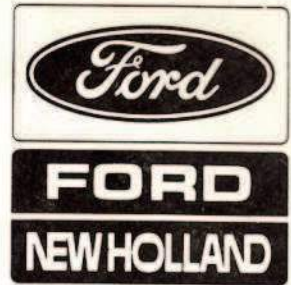


# FORD

## Operator's Manual

---



All Purpose and  
LCG Tractors  
2000, 3000, 4000  
and 5000



*The **BEST** source of  
information and help  
for old Ford tractors*



**My Ford Tractors**

[myfordtractors.com](http://myfordtractors.com)

# foreword

This manual has been prepared to assist you in the proper break-in, daily care, and operation of your new Ford Tractor. It contains specific information on the many built-in features of the tractor, the accessories and options that are available, general specifications of the tractor, safety precautions, instructions for making minor adjustments, and your tractor service policy.

Your tractor has been carefully inspected before leaving the factory and also by your Ford Tractor-Equipment Dealer, prior to delivery, to see that it is "ready to go." To keep it in this "ready to go" condition, it is important to follow regularly scheduled service periods as recommended in this manual.

The information herein applies to the Ford 2000, 3000, 4000, and 5000 All Purpose Tractors; to the Ford 2110 and 4110 LCG Tractors; and to the Ford 4000 SU Tractor. The Ford 3000 and 4000 Narrow Orchard Tractors are also covered. They are basically the same as the Ford 4110 LCG Tractors except that they use the Ford 3000 or 4000 All Purpose engine and they have shorter rear axle shafts for narrower rear wheel tread widths. Because of this similarity, all information that pertains to the Ford 4110 also pertains to the Narrow Orchard Tractors. Where differences do exist, specific information is presented.

Read this manual carefully before operating your tractor, and keep it in a convenient location for later reference. If, at any time, you have a service problem concerning your new tractor, remember that your Ford Tractor-Equipment Dealer has factory-trained service personnel, Genuine Ford Parts, and the necessary tools and equipment to best satisfy your service needs.

FORD TRACTOR OPERATIONS  
FORD MOTOR COMPANY

ISSUED TO:

ISSUED BY:

\_\_\_\_\_  
OWNER'S NAME

\_\_\_\_\_  
FORD TRACTOR-EQUIPMENT DEALER

\_\_\_\_\_  
MAILING ADDRESS

\_\_\_\_\_  
CITY

\_\_\_\_\_  
CITY

\_\_\_\_\_  
STATE - ZIP CODE

\_\_\_\_\_  
STATE - ZIP CODE

\_\_\_\_\_  
DELIVERY DATE

**PLEASE READ CAREFULLY:**


The **TRACTOR SERVICE POLICY** on page ii is your assurance that your Ford Tractor-Equipment Dealer has properly inspected and prepared your new tractor for delivery. Because the policy must be used whenever you request authorized service, we recommend that you keep this manual in a safe, convenient place.

The **WARRANTY** on page iii explains the coverage which is extended to your tractor during the warranty period. After you read the warranty ask your dealer to explain any points that you may not understand.

For a complete list of the pre-delivery service checks performed by your dealer, refer to **PRE-DELIVERY SERVICE** on the upper portion of pages 81 and 83. The copy on page 81 is your record of the service performed, and the copy on page 83, which is to be removed from the manual, is your dealer's record. **MAKE SURE THAT YOU AND THE DEALER SIGN BOTH COPIES.**

After you have operated your tractor for fifty hours, take this manual and your tractor to your dealer. He will then perform the factory recommended **50-HOUR SERVICE** as listed on the lower portions of pages 81 and 83—without charge—except for lubricant, hydraulic oil, or filters replaced as part of normal maintenance. **MAKE SURE THAT YOU AND THE DEALER SIGN BOTH COPIES.**

A **VEHICLE IDENTIFICATION PLATE** is located on the inside of the right-hand hood panel. The numbers on the plate are important should your tractor require future service. For your convenience, have your dealer record the numbers in the appropriate spaces below.

	
<b>TRACTOR NUMBER</b>	
<input type="text"/>	
<b>MODEL</b>	<b>UNIT</b>
<input type="text"/>	<input type="text"/>
<b>ENGINE</b>	
<input type="text"/>	
<b>TRANSMISSION</b>	<b>REAR AXLE</b>
<input type="text"/>	<input type="text"/>
<b>HYDRAULIC PUMP</b>	<b>HYDRAULIC LIFT</b>
<input type="text"/>	<input type="text"/>

# Tractor Service Policy

## **PROPER CARE OF YOUR TRACTOR**

Your new Ford Tractor has been properly inspected and prepared for delivery in the manner recommended by Ford Motor Company. Continued efficiency as well as economy in operation, however, depends upon the care received. Systematic attention to lubrication, regular inspection, and necessary adjustments by a Ford Tractor-Equipment dealer, usually will result in greater satisfaction for you.

## **WARRANTY SERVICE**

Should the replacement of any part become necessary under the warranty, the selling dealer will make the replacement without charge to you for the part or for the labor required to replace the part.

If you move to another location during the warranty period, the warranty service to which you are entitled under this policy will be performed by the nearest authorized Ford Tractor-Equipment Dealer without charge for material or labor when the equipment is brought into his shop. In order to obtain this service, you must present this policy to the servicing dealer before the warranty period expires. For your further information and guidance, any of the following services performed in connection with your Tractor under warranty are additional cost items and are not provided for in this Service Policy.

- 50-hour inspection (when performed by other than Selling Dealer)
- Pickup and delivery
- Service calls
- Replacement of filters and replenishing of lubricants
- Loaner equipment (made available at the discretion of the dealer who may or may not levy a charge for this service)

## **AFTER THE WARRANTY PERIOD HAS ELAPSED**

The selling Dealer will at any time give your Tractor a free inspection in his shop using factory-recommended equipment and the experience of trained mechanics and service analysts. He will advise you concerning the most economical and efficient maintenance. No charge will be made for such inspection, but repair or maintenance operations authorized by you will be charged for at his regular prices for such work.

# Warranty

FORD MOTOR COMPANY warrants to the owner each part of this Ford Tractor and/or Ford Equipment to be free, under normal use and service, from defects in material and workmanship for a period of six months from the date of sale to the original retail purchaser. This warranty shall be fulfilled by the Dealer (or, if the owner of the tractor is travelling or has become a resident of a different locality, by any authorized Ford Tractor-Equipment Dealer) by replacing or repairing at his place of business, free of charge including related labor, any such defective part.

This warranty shall not apply to (1.) vendor-warranted items such as tires and tubes, (2.) to normal maintenance services (such as engine tune-up, fuel system cleaning and wheel, brake and clutch adjustment), or (3.) to normal replacement of service items (such as filters, brake or clutch linings), or (4.) to deterioration of belts and exterior finish due to normal use or exposure, or (5.) to parts of any tractor or equipment that have been subject to negligence, alteration or accident, or which have been used with parts or equipment not made or supplied by FORD MOTOR COMPANY if, in the reasonable judgment of the Company and/or its authorized Dealers, such use affects its performance or reliability, or (6.) to parts of any tractor or equipment that have been altered or repaired outside of the Dealer's place of business in a manner so as, in the reasonable judgment of the Company, to affect its performance or reliability.

EXCEPT FOR PERSONAL INJURIES PROVED TO HAVE BEEN CAUSED BY A DEFECT, THIS WARRANTY IS EXPRESSLY IN LIEU OF ANY OTHER EXPRESS OR IMPLIED WARRANTY, INCLUDING ANY IMPLIED WARRANTY OF MERCHANTABILITY OR FITNESS AND OF ANY OTHER OBLIGATION ON THE PART OF THE COMPANY AND/OR ITS AUTHORIZED DEALERS.

**BATTERY ADJUSTMENT POLICY** — Any original Ford equipment or Ford accessory battery found to be defective after expiration of the regular six month warranty coverage to the original purchaser, will be replaced by any authorized Ford Tractor-Equipment Dealer on a pro rata basis for a period from 7 to 24 months, but not exceeding 24 months from date of sale to original purchaser.

FORD MOTOR COMPANY reserves the right to make changes in its products at any time and without prior notice. When such changes are made, neither FORD MOTOR COMPANY or its Dealers assume any obligation to make these changes in products previously manufactured.

This warranty covers those Ford Tractors and units of Ford Equipment which are distributed by Tractor and Implement Operations (U.S.) and subsequently sold by authorized Ford Tractor-Equipment Dealers for use within the continental boundaries of the United States only.

## WATCH YOUR PROOF-METER HOURS LUBRICATION AND MAINTENANCE SERVICE INTERVALS

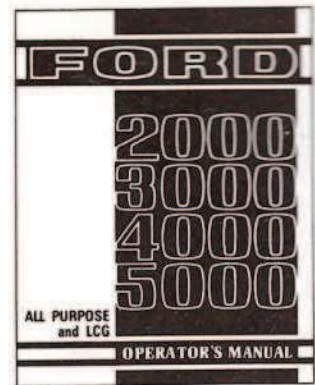
LUBRICATION AND MAINTENANCE ITEM	CHECK	CLEAN	LUBE	CHANGE	ADJUST	SERVICE INTERVAL
Air Cleaner (Oil Bath) Pre-Cleaner Bowl (Acc) Engine Oil Level Radiator (Cooling System)	•	•				Every 10 Hours or Daily
Air Cleaner Element (Dry Type) Air Cleaner (Oil Bath) Sediment Bowl Fuel Filters Battery Distributor Lubrication Fittings: Front Wheel Spindles Brake Pedal Pivots Clutch Pedal Pivot Steering-Center Arm Power Steering Cylinders Diff. Lock Pedal Pivots Hydraulic Lift Linkage Rear Axle Oil Level Belt Pulley Oil Level Tires Clutch Pedal			•	•	•	Every 50 Hours
Engine Oil and Filter Air Cleaner Element (Dry Type) Distributor: Cam Cam Center Spindle Governor Weight Mech. Breaker Points Spark Plugs Fan Belt In-Line Breather Power Steering Reservoir Select-O-Speed Trans. mission Oil Level Manual Shift Transmission Oil Level		Wash		•	•	Every 300 Hours
Air Cleaner Element (Dry Type) Air Cleaner (Oil Bath) Disassemble and Clean Fuel Injectors Distributor Points Spark Plugs Valve Clearance Steering Housing Oil Level Power Steering Oil & Filter Select-O-Speed Bands Front Wheel Bearings			•	•	•	Every 600 Hours
Fuel Filters Rear Axle Oil Manual Shift Trans. Oil Belt Pulley Oil				•	•	Every 1200 Hours
Hydraulic Filters Select-O-Speed Trans. Oil Filter				•	•	Every 2400 Hours
Radiator Coolant Rear Axle Oil				•	•	Seasonal

Refer to your Operator's Manual  
for additional information

CS9N-6813-B

To emphasize the importance of lubrication and maintenance service intervals, the decal reproduced here is placed on the inside of the tractor right-hand hood panel. The information shown has been condensed from the lubrication and maintenance information in this manual. Watch your Proof-Meter hours and use the decal as a reminder of the services required by your tractor.

# contents



	safety precautions	2
<b>controls and instruments</b>	<b>3</b>	
	seat, light, and engine controls	4
	brake and rear axle controls	7
	Select-O-Speed transmission and P.T.O. controls	7
	manual shift transmission and P.T.O. controls	9
	hydraulic lift system controls	10
	<b>operation</b>	<b>13</b>
	break-in procedures	14
	starting the engine	14
	stopping the engine	16
	operating Select-O-Speed tractors and P.T.O.	17
	operating manual shift tractors and P.T.O.	22
	operating differential lock	25
	operating belt pulley (accessory)	25
	operating hydraulic lift system	27
	lift linkage and drawbar	31
	wheel tread settings	35
	tractor weighting	41
<b>lubrication and maintenance</b>	<b>45</b>	
	lubrication and maintenance charts	46
	fuels and lubricants	48
	fuel and lubricant service procedures	50
	general maintenance	61
	tractor storage	73
	accessories	74
	<b>specifications</b>	<b>75</b>
<b>pre-delivery and 50-hour service</b>	<b>81</b>	
	<b>Index</b>	<b>85</b>

# safety precautions

The following precautions are suggested to help prevent accidents.

1. Use the handholds and step plates when getting on and off the tractor.
2. Always use the seat belt only when the roll bar is installed. Never use the seat belt if the roll bar is removed from the tractor.
3. Never start the engine while standing beside the tractor. Always sit in the tractor seat while starting the engine.
4. Do not bypass the safety starter switch. Consult your Ford Tractor-Equipment Dealer if your safety starter controls are malfunctioning.
5. Do not permit anyone to ride on the tractor with the operator.
6. Always shut off the engine and apply the parking brake before getting off the tractor.
7. Never engage the parking brake when the tractor is moving.
8. The operator should never get off the tractor while it is in motion.
9. Use care when operating on steep grades to maintain proper stability.
10. Always drive the tractor at speeds compatible with safety, especially when operating over rough ground, crossing ditches, slopes, or when turning.
11. Keep the tractor in gear when going downhill.
12. When operating P.T.O.-driven equipment, always shut off the engine and wait for the P.T.O. to stop turning before getting off the tractor and before disconnecting the equipment.
13. When operating stationary P.T.O. equipment, always apply the parking brake and block the rear wheels both in front and back. For tractors with a Select-O-Speed transmission, also position the drive line disengagement lever in the disconnect position.
14. Always keep the tractor brakes in good operating condition.
15. Never run the tractor engine in a closed building without adequate ventilation, as the exhaust fumes are very dangerous.
16. Never install or remove a belt while the belt pulley is in motion.
17. Never clean or adjust P.T.O.-driven equipment with the tractor engine running.
18. Never wear loose clothing when operating the power take-off, or around equipment that is rotating.
19. Always use the drawbar for pull-type work. Never pull from the upper link or rear axle as the tractor can tip backward.
20. Never leave equipment in the raised position.
21. If the tractor is stuck, back out to prevent an upset. If logs are used, always put them behind the rear wheels and back out.
22. Make sure the P.T.O. shield is installed when using P.T.O.-driven equipment, and always replace the P.T.O. shaft cap when the P.T.O. is not being used.
23. Make sure the stabilizers are installed when using the hydraulic lift linkage.
24. If the front end tends to rise, install front end or front wheel weights. Do not continue to operate with a "light" front end.
25. Use the flasher warning lamp when traveling on public roads, day or night, unless prohibited by law in your state.
26. Read this manual carefully to acquaint yourself with the tractor. Working with unfamiliar equipment can lead to accidents.

Whenever you see this symbol



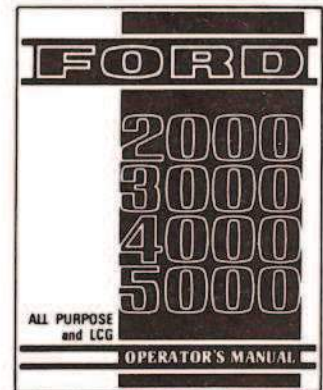
it means:

**ATTENTION! BECOME ALERT! YOUR SAFETY IS INVOLVED!**



# controls

# and



# instruments

Before operating your new tractor, familiarize yourself with the location and function of all controls and instruments as described on the following pages.

The instruments and warning lights are centrally located so that you can tell at a glance whether the tractor is operating properly. The warning lights also warn you of possible trouble before it becomes serious.



**Know your controls and instruments  
to assure Safe Operation.**

# CONTROLS AND INSTRUMENTS

## SEAT, LIGHT, AND ENGINE CONTROLS

### TRACTOR SEAT

Your new Ford Tractor is equipped with either a pan seat, Figure 1, or deluxe contoured seat, Figure 2.

**Pan Seat:** If the seat is not in the most comfortable position, it can be moved closer to or farther from the steering wheel by removing the attaching nuts, Figure 1, and repositioning the seat as desired. The seat can also be tilted back, permitting you to stand.

**Deluxe Contoured Seat:** If the seat is not in the most comfortable position, it can be moved up and rearward, or down and forward by loosening the height adjustment nuts shown in Figure 2 (two each side). The seat can also be moved forward or rearward without affecting its height by loosening the attaching nuts at the base of the seat.

Soft or firm flotation is obtained with the flotation adjustment knob and the soft/firm selector lever, Figure 2. To adjust the seat for flotation, position the soft/firm selector lever at the top of its slot, then turn the flotation adjustment knob to the right for a firm ride or to the left for a soft ride. A firmer ride for rough terrain can be obtained by moving the soft/firm selector lever to the bottom of its slot. The seat can also be tilted back, permitting you to stand. Tilt the seat back when not in use to help protect it from the weather.

**NOTE:** If your tractor is equipped with a seat belt, a latch located under the front edge of the seat must be pulled forward before the seat can be tilted back.

### SAFETY ROLL BAR AND SEAT BELT (OPTIONAL)

If your tractor is equipped with a safety roll bar and seat belt, remember that the protection offered by the roll bar

alone will be less if your seat belt is not buckled. Use your seat belt—it may save your life. **DO NOT** use the seat belt if the roll bar is removed from the tractor.



**CAUTION:** Never attach chains, ropes, or the like to the roll bar for pulling purposes; this can be very dangerous, as the tractor can tip backward. Always pull from the tractor drawbar.

Be careful when driving through door openings or under low overhead objects. Make sure there is sufficient clearance for the roll bar to clear the structure or object.

### ADJUSTING THE SEAT BELT

To lengthen the belt, tip the buckle end down and pull on the buckle until the ends can be joined.

To shorten the belt, buckle it, then pull on the loose end until the belt is snug.

If the seat belt is to be cleaned, use soap and water. Do not use carbon tetrachloride, naphtha, etc., as these will weaken the webbing. Also, for the same reason, do not bleach or redye the webbing.

### FLASHER WARNING LAMP

Your new Ford Tractor is equipped with a flasher warning lamp as standard equipment. See Figure 3. The spring-loaded push-type switch on the lamp housing is used to turn the flasher on or off.

The light switch, Figure 4, must be in its intermediate or full out position before the flasher will operate.

For your protection, use the flasher warning lamp when traveling on public roads, day or night, unless prohibited by law in your state.



Figure 1  
Pan Seat

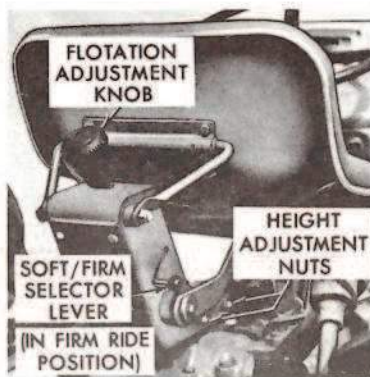


Figure 2  
Deluxe Contoured Seat

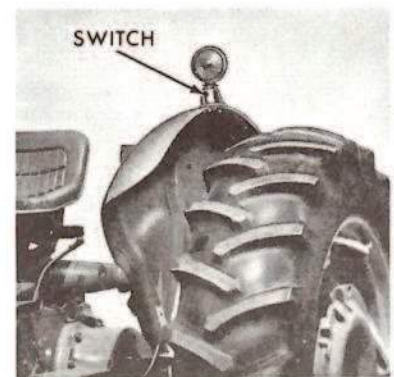
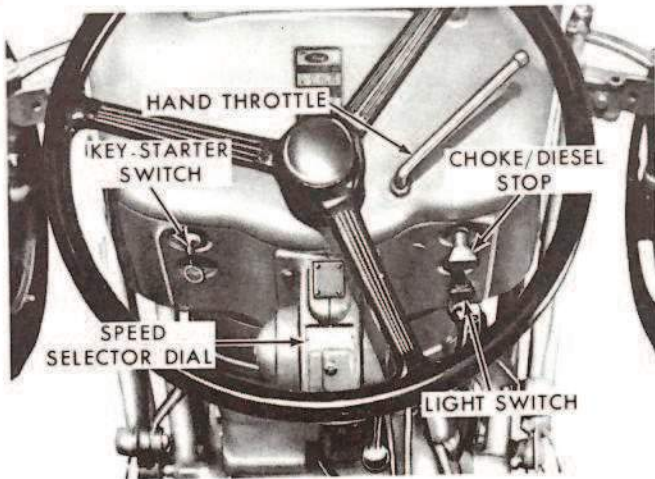


Figure 3  
Flasher Warning Lamp



**Figure 4**  
Engine Controls

#### LIGHT SWITCH

The light switch, shown in Figure 4, is a push-pull type switch. Its positions are:

- Full in ..... Off
- Intermediate..... Instrument lights, tail lamp, flasher warning lamp, and accessory lights
- Full out . . . . Headlamps, tail lamp, flasher warning lamp, instrument lights, and accessory lights

#### KEY-STARTER SWITCH

The key-starter switch is shown in Figure 4. Turning the key to the right to its "ON" position will activate the warning lights and instruments. Turning the key further right to its "START" position will start the engine. Upon release, the key will spring-return to the "ON" position.

The starting circuit can only be activated when the transmission shift lever is in Neutral, Park (P) on Select-O-Speed tractors. Refer to page 14 for complete starting instructions.

#### DIESEL ENGINE STOP CONTROL

The diesel engine stop control, shown in Figure 4, is used with the key-starter switch to stop and start the engine. The control must be pushed in before the engine can be started. Pulling the control out will stop the engine. Refer to "STOPPING THE ENGINE" on page 16 for additional information.

#### GASOLINE ENGINE CHOKE CONTROL

The gasoline engine choke control, shown in Figure 4, is used to "choke" the engine for easier starting during cold weather. Maximum choking occurs when the control is pulled all the way out. Refer to "Cold Weather Starting" on page 14 for use of the choke.

#### HAND THROTTLE

The hand throttle is shown in Figure 4. Pull the throttle rearward to increase engine rpm. Push the throttle forward to decrease engine rpm.

#### FOOT THROTTLE Ford 2110 and 4110

The foot throttle, shown in Figure 5, can be used separately, or in conjunction with, the hand throttle. With the hand throttle set at a selected engine rpm, the foot throttle can be used to increase engine rpm to its maximum speed. Upon release of the foot throttle, the engine speed will return to idle or to the rpm which the hand throttle has been set to maintain.

#### FUEL GAUGE

The fuel gauge is shown in Figure 6. The relationship of the needle to the quarter marks on the gauge indicates the amount of fuel in the tank.

#### TEMPERATURE GAUGE

The engine coolant temperature gauge is shown in Figure 6. When the needle is between the blue (cold) and red (hot) marks the engine coolant is at its normal operating temperature.



**Figure 5**  
Foot Throttle—Ford 2110 and 4110

## CONTROLS AND INSTRUMENTS

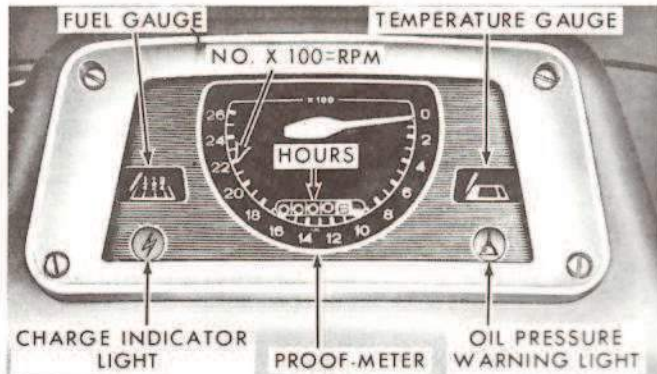


Figure 6  
Instrument Cluster

### WARNING LIGHTS

The warning lights are shown in Figure 6. When the key-starter switch is turned "ON" the lights will come on. When the engine is running the lights will go out as engine rpm is increased. If they do not go out:

- **Engine Oil Pressure Warning Light:** Stop the engine immediately and investigate the cause. It is important to remember that this light indicates oil pressure only. The operator must still check the crankcase for proper oil level.
- **Charge Indicator Warning Light:** It is an indication that the battery is not being charged. Investigate the cause as soon as possible, otherwise the battery will become fully discharged.

### PROOF-METER

The Proof-Meter is the large instrument in the center of the instrument cluster, Figure 6. The Proof-Meter indicates:

- The hours and portions of hours your tractor has operated, based on an average engine speed of 1666 rpm. Engine speeds below 1666 rpm accumulate hours at a

slower rate than clock hours. Engine speeds above 1666 rpm build up hours faster than clock hours. Use the Proof-Meter as a guide to determine hourly service and maintenance intervals.

- The engine revolutions per minute. Use the Proof-Meter in conjunction with the transmission shift decal to determine the tractor ground speed. The Proof-Meter also is helpful when operating P.T.O. equipment. Additional P.T.O. and ground speed information can be found on pages 18 and 23.

### DIESEL ENGINE EXCESS FUEL BUTTON

#### In-Line Injection Pump

The excess fuel button is located on the fuel injection pump of Ford 3000 and 5000 Tractors equipped with the in-line type pump, Figure 7. The button should be pushed in before starting the engine at temperatures below 40° F. Refer to "Cold Weather Starting" on page 16 for use of the button.

### AIR CLEANER RESTRICTION INDICATOR (OPTIONAL)

#### Gasoline Engine

If your tractor is equipped with the air cleaner restriction indicator, shown in Figure 8, the indicator should be checked daily or every 10 hours of operation. If the sight glass of the indicator is completely red when the engine is off, service the air cleaner (dry element type) as covered on page 54.

### FUEL SHUT-OFF VALVE

The fuel shut-off valve, shown in Figure 9, is located on the right side of the tractor under the fuel tank. Turning the valve to the right will stop the flow of fuel from the tank.

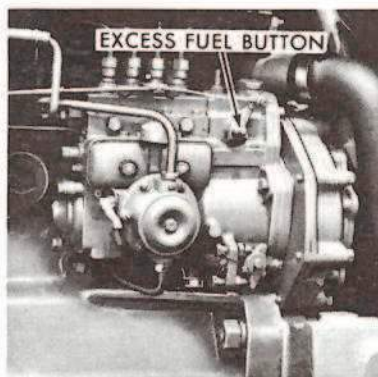


Figure 7  
Excess Fuel Button—In-Line  
Injection Pump

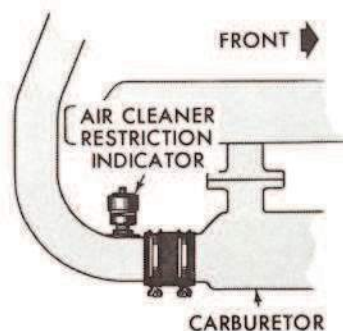


Figure 8  
Air Cleaner Restriction Indicator  
(Optional on Gasoline Engines)

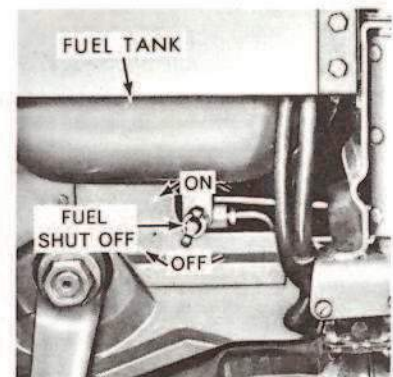
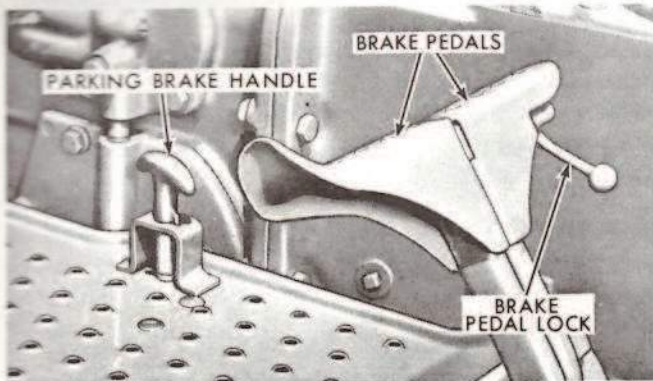
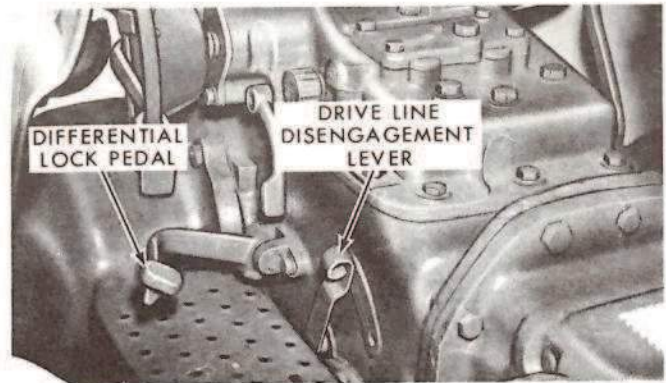


Figure 9  
Fuel Shut-Off Valve



**Figure 10**  
Brake Controls



**Figure 12**  
Rear Axle Controls—Ford 5000

## BRAKE AND REAR AXLE CONTROLS

### BRAKE PEDALS

The brake pedals are shown in Figure 10. The right brake pedal is used to brake the right rear wheel. The left pedal is used to brake the left rear wheel. Depress both pedals simultaneously to stop the tractor.

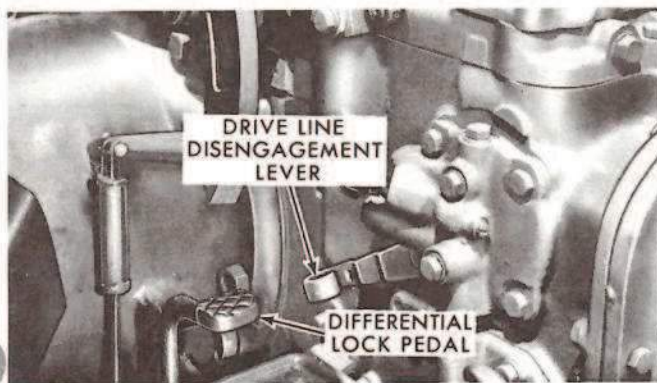
To assist in making sharp turns at slow speeds, depress the right or left brake pedal as required.



**CAUTION:** *When operating the tractor at high speeds, never attempt to make sharp turns by using the brakes.*

### BRAKE PEDAL LOCK

The brake pedal lock, shown in Figure 10, is used to secure the brake pedals together. Lock the pedals together whenever the tractor is operated at high speeds or at any time the tractor is used on the highway.



**Figure 11**  
Rear Axle Controls—All Models Except Ford 5000  
(Ford 4000 Shown)

### PARKING BRAKE HANDLE

The parking brake handle, shown in Figure 10, is used for locking the brake pedals in the applied position. The parking brake should be applied whenever the tractor is parked.

#### To apply the brake:

- Lock the brake pedals together with the brake pedal lock.
- Pull up on the parking brake handle and turn it ¼ turn.
- Depress both brake pedals. A ratchet mechanism under the platform will hold the pedals in the applied position.

#### To release the parking brake:

- Turn the handle ¼ turn so the tabs will enter the slot in the handle guide.
- Depress the brake pedals to release the ratchet.
- Unlock the brake pedals if operating conditions require independent rear wheel braking action.

### DIFFERENTIAL LOCK PEDAL

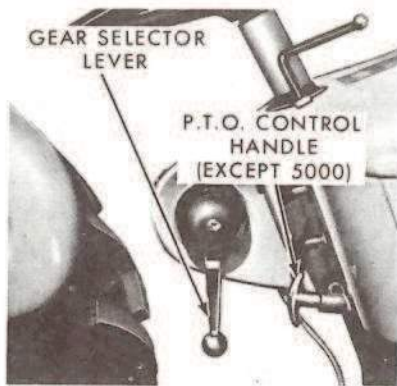
The differential lock pedal is shown in Figures 11 and 12. Depressing the pedal locks the rear axle shafts together, providing for additional traction in wet or loose soil. Refer to page 25 for differential lock operating information.

## SELECT-O-SPEED TRANSMISSION AND P.T.O. CONTROLS

### SELECT-O-SPEED GEAR SELECTOR LEVER

The Select-O-Speed gear selector lever, shown in Figure 13, is used for selecting ten forward speeds (indicated by numerals 1 to 10), two reverse speeds (R<sub>1</sub> and R<sub>2</sub>), a park

## CONTROLS AND INSTRUMENTS



**Figure 13**  
Select-O-Speed Controls

(P), and a neutral position (N). The selector dial is illuminated when the key-starter switch is turned on. Refer to "Operating Select-O-Speed Tractors and P.T.O." on page 17 for additional gear selector lever operating information.

### SELECT-O-SPEED INCHING PEDAL

The Select-O-Speed inching pedal, shown in Figure 14, provides for quick disengagement of power to the rear wheels, and permits you to ease the tractor into equipment for easy attachment. Always depress the pedal when starting the tractor, then ease it up to get the tractor moving. Refer to "Operating Select-O-Speed Tractors and P.T.O." on page 17 for additional inching pedal operating information.

### SELECT-O-SPEED INDEPENDENT P.T.O. CONTROL HANDLE/LEVER

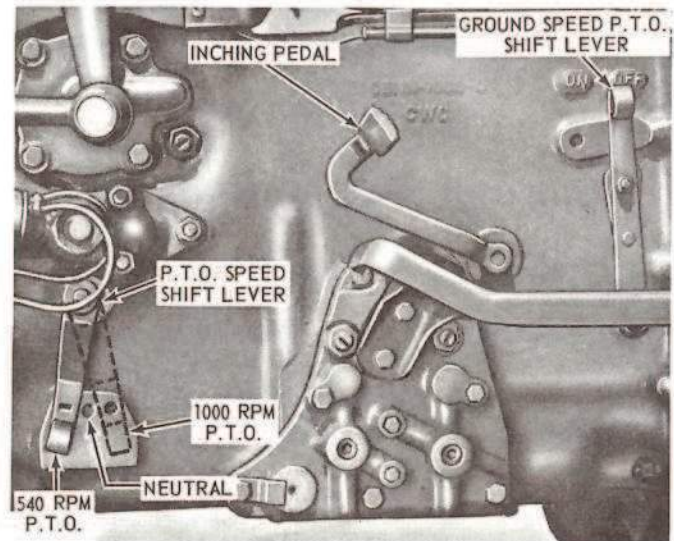
**Ford 2110, 3000, 4000, and 4110:** The Select-O-Speed P.T.O. control handle, shown in Figure 13, is used to engage and disengage the P.T.O. on Ford 2110, 3000, 4000, and 4110 Tractors. To engage the P.T.O., pull the handle all the way out. To disengage the P.T.O., push the handle all the way in.



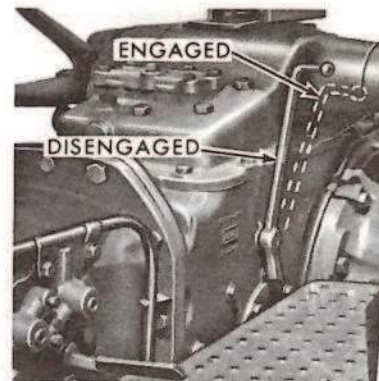
**Figure 14**  
Select-O-Speed Inching Pedal

If your tractor is equipped with the Deluxe Select-O-Speed transmission, the ground speed P.T.O. shift lever, Figure 15, must be in the "OFF" position before the P.T.O. control handle can be moved. Refer to "Select-O-Speed Independent P.T.O. Operation" on page 19 for detailed operating instructions.

**IMPORTANT:** Make sure the P.T.O. control handle is always fully in or fully out to prevent excessive wear to the P.T.O. clutch.



**Figure 15**  
Deluxe Select-O-Speed Controls



**Figure 16**  
Independent P.T.O. Control  
Lever—Ford 5000

**Ford 5000:** The Select-O-Speed P.T.O. control lever, shown in Figure 16, is used to engage and disengage the P.T.O. on Ford 5000 Tractors. To engage the P.T.O., move the lever sharply rearward. To disengage the P.T.O., move the lever sharply forward. Refer to "Select-O-Speed Independent P.T.O. Operation" on page 19 for detailed operating instructions.

**IMPORTANT:** Make sure the P.T.O. control lever is always fully rearward or fully forward to prevent excessive wear to the P.T.O. clutch.

**DELUXE SELECT-O-SPEED P.T.O. SPEED SHIFT LEVER**

**Ford 3000, 4000, and 4110**

When the P.T.O. is not in use, the P.T.O. speed shift lever, shown in Figure 15, should be in the neutral position. When operating 540 rpm P.T.O. equipment, move the lever forward. When operating 1000 rpm P.T.O. equipment, move the lever rearward. Never move the lever when the tractor engine is running. Also, when operating the Deluxe Select-O-Speed P.T.O., make sure the correct P.T.O. shaft is used as outlined on page 18, "P.T.O. Shafts."

**DELUXE SELECT-O-SPEED GROUND SPEED P.T.O. SHIFT LEVER**

**Ford 3000, 4000, and 4110**

The ground speed P.T.O. shift lever shown in Figure 15, permits the operating speed of P.T.O. equipment to be in direct proportion to forward travel, regardless of tractor engine speed. To operate in ground drive P.T.O., move the lever forward to the "ON" position. Make sure the P.T.O. control handle, Figure 13, is pushed all the way in, otherwise the ground speed P.T.O. shift lever cannot be moved. Refer to page 20 for additional ground speed P.T.O. information.

**IMPORTANT:** Do not move the ground speed P.T.O. shift lever while the tractor is in motion. Also, before backing the tractor, the lever must be moved to the "OFF" position. Failure to do this may result in serious damage to the equipment.

**SELECT-O-SPEED DRIVE LINE DISENGAGEMENT LEVER**

Because the Select-O-Speed transmission automatically "locks up" whenever the engine is not running, the tractor cannot be towed or pushed unless the drive line disengagement lever, shown in Figures 11 and 12, is moved:

- Up ..... Ford 2110, 3000, 4000, and 4110
- Forward ..... Ford 5000

**CAUTION:** The drive line disengagement lever should only be used when towing or pushing the tractor or when operating stationary P.T.O. equipment. Moving the lever to the positions listed above will allow the tractor to roll. Always apply the parking brake and block the wheels if the lever is moved for reasons other than towing. Refer to page 22 for additional towing information and to page 22 for operation of stationary P.T.O. equipment.



**MANUAL SHIFT TRANSMISSION AND P.T.O. CONTROLS**

**6- AND 8-SPEED TRANSMISSION GEARSHIFT LEVERS**

The 6- and 8-speed transmission gearshift levers are shown in Figure 17. A diagram of the shift pattern is provided on a plate directly below the Proof-Meter.

The transmission gearshift lever is the longer of the two levers and is used with the high-low shift lever to select one of the forward or reverse gears. Always depress the clutch pedal before moving either lever. Refer to "Manual Shift Transmission Operation" on page 22 for operating information.

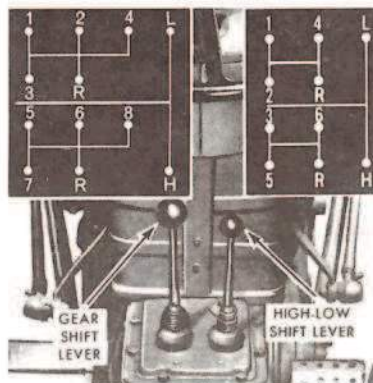
**CLUTCH PEDAL**

On manual shift transmission tractors, the foot-operated clutch pedal, Figure 18, must be completely depressed to stop forward travel and P.T.O. shaft rotation. Always depress the pedal when changing gear ratios.

On tractors with live P.T.O., the clutch pedal has three positions as shown in Figure 18. Depressing the pedal halfway will stop the tractor, but the P.T.O. shaft will continue to rotate. Depressing the pedal completely will stop the tractor and the P.T.O. shaft. Refer to "Transmission and Live P.T.O. Operation (Manual Transmission)" on page 23 for use of the clutch pedal when operating the P.T.O.

**TRANSMISSION AND LIVE P.T.O. CONTROL LEVER (MANUAL TRANSMISSION)**

Transmission P.T.O. means the P.T.O. shaft will turn only when the clutch is engaged and will stop turning when the clutch pedal is depressed to stop the tractor. Live P.T.O.



**Figure 17**  
**6- and 8-Speed Transmission Gearshift Levers**

## CONTROLS AND INSTRUMENTS

operates basically in the same manner except that an intermediate clutch pedal position, Figure 18, stops the tractor without stopping the P.T.O. shaft.

The transmission and live P.T.O. control lever used with the 6-speed and 8-speed transmission tractors is shown in Figure 18. The lever engages and disengages the P.T.O. If the tractor engine is running, always depress the clutch pedal fully before moving the lever. Move the lever rearward to engage the P.T.O. and forward to disengage. Refer to "Transmission and Live P.T.O. Operation (Manual Transmission)" on page 23 for detailed operating instructions.

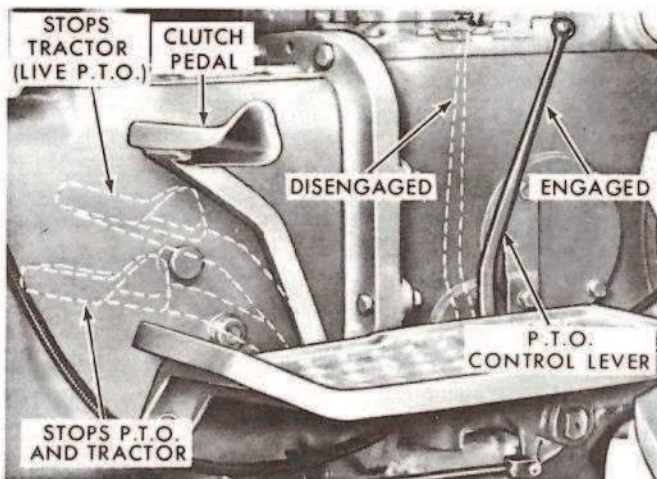


Figure 18  
Transmission and Live P.T.O. Control Lever and Clutch Pedal—6-Speed and 8-Speed

### INDEPENDENT P.T.O. CONTROL LEVER (MANUAL TRANSMISSION)

Ford 4000, 4000 SU, and 5000

The independent P.T.O. control lever is shown in Figure 19 for the Ford 4000 and 4000 SU Tractors, and in Figure 16 for the Ford 5000 Tractor. Move the lever sharply to engage or disengage the P.T.O. The P.T.O. is "independent," which means that it can be engaged or disengaged while the tractor is either moving or stopped. The lever positions are listed below. Refer to "Independent P.T.O. Operation (Manual Transmission)" on page 24 for detailed operating instructions.

TRACTOR	P.T.O. CONTROL LEVER POSITION	
	Engaged	Disengaged
Ford 4000 and 4000 SU	Forward	Rearward
Ford 5000	Rearward	Forward

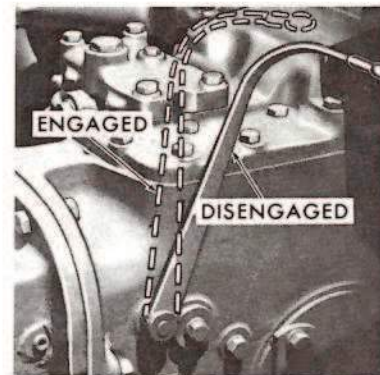


Figure 19  
Independent P.T.O. Control Lever—Ford 4000 and 4000 SU

## HYDRAULIC LIFT SYSTEM CONTROLS

### HYDRAULIC LIFT CONTROL LEVER

The hydraulic lift control lever is shown in Figures 20, 21, and 22. To raise the hydraulic lift arms, pull the lever up. To lower the lift arms, push the lever down. The adjustable stop is provided for locating the lever at any position in the quadrant.

### HYDRAULIC SELECTOR LEVER

The hydraulic selector lever is shown in Figures 20, 21, and 22. The lever has two positions: **down** for constant

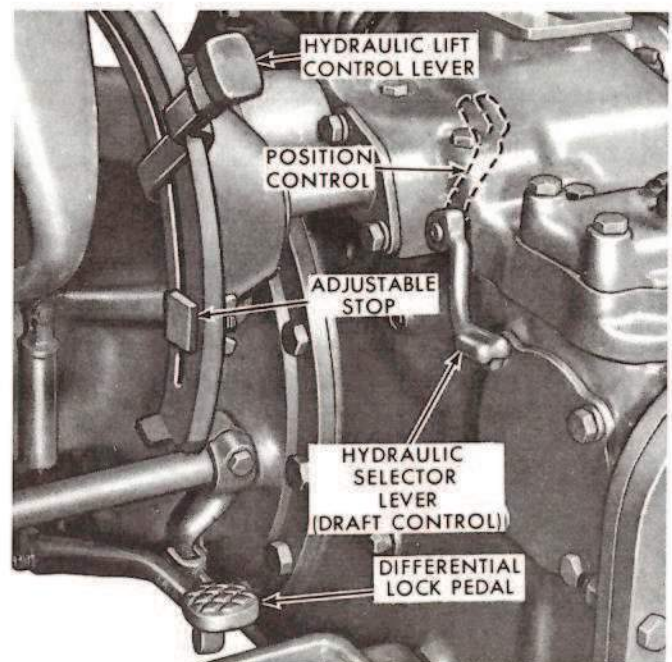
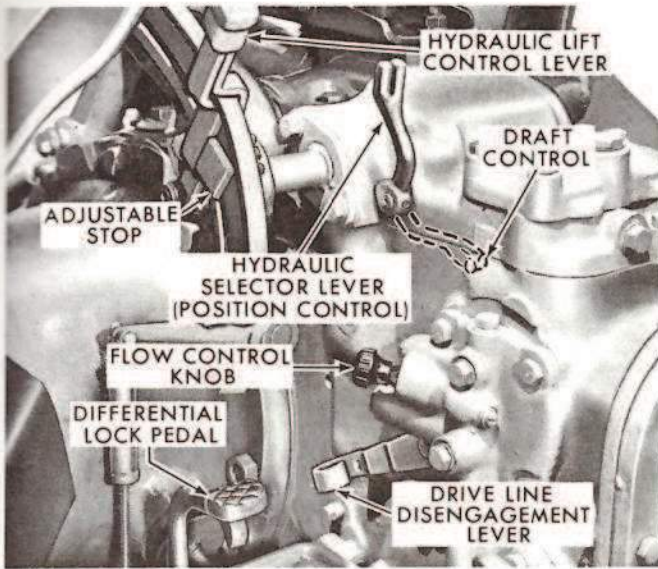


Figure 20  
Hydraulic Lift Controls—Ford 2000, 2110, and 4110





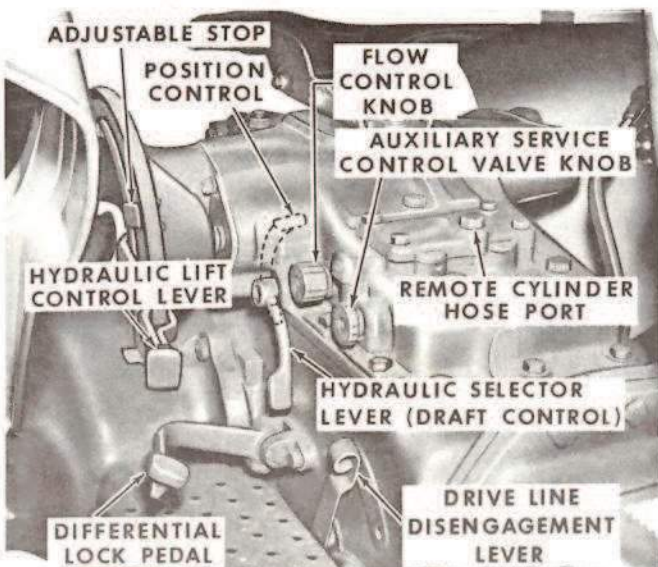
**Figure 21**  
Hydraulic Lift Controls—Ford 3000, 4000, and 4000 SU  
(4000 Shown)

draft control and **up** for implement position control. Refer to "Operating Hydraulic Lift System" on page 27 for details pertaining to draft and position control.

#### FLOW CONTROL KNOB

Ford 3000, 4000, 4000 SU, and 5000

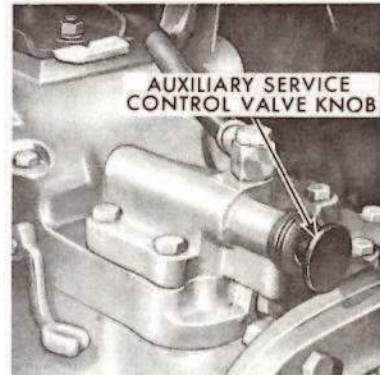
The flow control knob is shown in Figures 21 and 22. Turning the knob "in" will speed the response of the tractor hydraulic lift system, and turning the knob "out" will slow the response. Refer to "Flow Control" on page 28 for additional operating information.



**Figure 22**  
Hydraulic Lift Controls—Ford 5000

#### AUXILIARY SERVICE CONTROL VALVE KNOB

The auxiliary service control valve knob permits the use of single-acting remote cylinders. The knob, shown in Figure 22, is standard equipment on the Ford 5000 Tractor. The knob, as shown in Figure 23, is an accessory for all other models. The knob positions for various operating conditions are listed below. Operating instructions are covered on page 28.



**Figure 23**  
Auxiliary Service Control Valve  
Knob—All Models Except  
Ford 5000


#### AUXILIARY SERVICE CONTROL KNOB POSITION

TRACTOR	Lift Linkage Operation	Remote Cylinder Operation	Lift and Remote Cylinder Operation
Ford 2000, 2110, 3000, 4000, 4000 SU, and 4110	Full "in"	Full "out"	Half "out"
Ford 5000	Full "in"	Full "out"	*

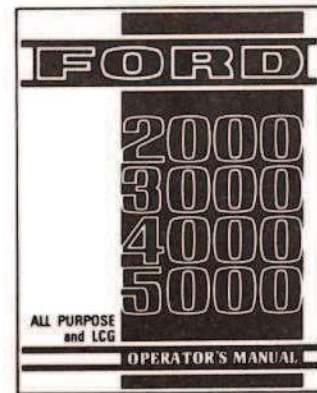
*\*The tractor hydraulic lift system and remote cylinder (single-acting) can be operated simultaneously on the Ford 5000 Tractor by connecting the remote cylinder hose directly into the lift cylinder through the remote cylinder hose port on the accessory cover. See Figure 22. Simultaneous operation does, however, depend on the amount of weight that is to be lifted by the lift links and remote cylinder. If the weight to be lifted by the cylinder is greater than the weight on the lift links, the links will rise to the top of their travel, making the hydraulic system inactive.*

#### REMOTE CONTROL VALVES (OPTIONAL)

Single and double spool remote control valves are available for use on your Ford Tractor. For further information on remote control valves refer to page 29.

 *whatever your service needs ...  
whatever your parts or accessories  
requirements ... your Ford Tractor-  
Equipment Dealer is equipped  
to serve you better... for less!*

# operation



After familiarizing yourself with the controls and instruments, study the information in this section carefully, giving special attention to the break-in procedures.

To obtain the most from your new Ford Tractor, follow the instructions provided. This will help you get the job done easier and faster.



A careful operator is the best  
insurance against accidents.

## OPERATION

### BREAK-IN PROCEDURES

Your new Ford Tractor will provide long and dependable service if given proper care during the 50-hour break-in period. During the first 50 hours of operation:

1. Avoid "lugging" the engine. Operating in too high a gear under heavy load may cause excessive engine "lugging." Harmful "lugging" occurs when the engine will not respond to a throttle increase.
2. Use the lower gear ratios when pulling heavy loads and avoid continuous operation at constant engine speeds. You will save fuel and minimize engine wear by selecting the correct gear ratio for a particular operation. Operating the tractor in low gear with a light load and high engine speed will waste fuel.
3. Avoid prolonged operation at either high or low engine speeds without a load on the engine.
4. Check the instruments frequently and keep the radiator and oil reservoirs filled to their recommended levels. Daily checks include:
  - Engine oil level
  - Power steering oil level
  - Transmission oil level
  - Tractor hydraulic lift system oil level (rear axle)
  - Air cleaner restriction indicator

### STARTING THE ENGINE

A safety starter switch on Ford Tractors allows the starting motor to be used only when the transmission high-low shift lever is in neutral, park (P) on Select-O-Speed Tractors. Therefore, always shift to neutral, park (P) on Select-O-Speed, before starting the engine. **NEVER ATTEMPT TO START THE ENGINE WHILE STANDING BESIDE THE TRACTOR—ALWAYS SIT IN THE SEAT.**

**IMPORTANT:** Do not crank the starting motor continuously for more than 30 seconds; doing so may cause starting motor failure.

#### WARM WEATHER STARTING

To start a cold engine in warm weather or to start an engine that is warm:

1. **Select-O-Speed Transmissions:** Depress the inching pedal and move the gear selector lever to the park (P) position.  
**Manual Shift Transmissions:** Depress the clutch pedal and move the high-low shift lever to the neutral position.

2. **Gasoline Engines:** Move the hand throttle to the closed position.

**Diesel Engines:** Move the hand throttle to the half-open position. Make sure the diesel engine stop control is pushed all the way in.

3. Turn the starter key to its "START" position, Figure 24. When the engine starts, release the key. Check to be sure the warning lights go out. If the engine fails to start after cranking for approximately 10 seconds, refer to the following "Cold Weather Starting" information.

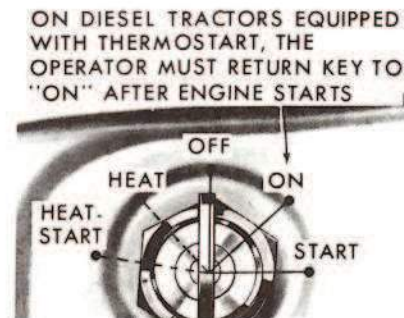


Figure 24  
Key-Starter Switch Positions

#### COLD WEATHER STARTING

**Gasoline Engines:** If the engine fails to start using the preceding warm weather starting procedure or when starting a cold engine, use the choke as covered in this procedure.

1. **Select-O-Speed Transmissions:** Depress the inching pedal and move the gear selector lever to the park (P) position.  
**Manual Shift Transmissions:** Depress the clutch pedal and move the high-low shift lever to the neutral position.
2. Open the hand throttle slightly and pull the choke all the way out.
3. Turn the starter key to its "START" position. Release the key when the engine first begins to fire, then partially push the choke in. Check to be sure the warning lights go out.
4. Run the engine at about 1000 rpm for approximately 30 to 60 seconds before driving the tractor. A faster warm-up can then be achieved if the tractor is placed under a light load.

**IMPORTANT:** The choke should be pushed all the way in as soon as possible. Prolonged operation with the choke out will cause high fuel consumption and possibly excessive engine wear due to oil dilution.

**Diesel Engines:** If an engine equipped with the in-line fuel injection pump, Figure 7, fails to start using the warm weather starting procedure outlined on page 14, use the excess fuel button as outlined in this procedure. When temperatures are extremely low, it is recommended that the Automatic Thermostart, the Ether Spray Primer, or the Coolant Immersion Heater be used as a starting aid. Refer to "Cold Weather Starting Aids" below.

1. **Select-O-Speed Transmissions:** Depress the inching pedal and move the gear selector lever to the park (P) position.

**Manual Shift Transmissions:** Depress the clutch pedal and move the high-low shift lever to the neutral position.

2. Move the hand throttle to the wide-open position. Push the excess fuel button "in" to increase fuel delivery, then reduce the throttle setting to the half-open position.

3. Turn the starter key to its "START" position. When the engine starts, release the key. Check to be sure the warning lights go out.

**NOTE:** If the engine starts and then stops, make sure the excess fuel button is pushed "in" before attempting to restart the engine. The button automatically "pops out" once the engine is running. To benefit from the device, the button should be pushed in when the hand throttle is in the wide-open position. The throttle should then be returned to the half-open position before starting the engine.

#### COLD WEATHER STARTING AIDS

**Automatic Thermostart:** The automatic thermostart is standard equipment on diesel tractors equipped with a Select-O-Speed transmission, and is optional on diesel tractors with a manual shift transmission.

The unit is effective in temperatures down to:

- +10° F. . . . . Ford 2110 and 3000 w/Select-O-Speed
- 0° F. . . . . Ford 4000, 4110, and 5000 w/Select-O-Speed
- 0° F. . . . . All Models w/Manual Transmission

The automatic thermostart heating element is installed in the air intake manifold to ignite fuel in the manifold before it enters the combustion chamber. The element is operated with the key-starter switch. To start a cold engine with the thermostart:

1. **Select-O-Speed Transmissions:** Depress the inching pedal and move the gear selector lever to the park (P) position.

**Manual Shift Transmissions:** Depress the clutch pedal and move the high-low shift lever to the neutral position.

2. **In-Line Injection Pump:** Move the hand throttle to the wide-open position. Push the excess fuel button "in" to increase fuel delivery, then reduce the throttle setting to the half-open position.

**Distributor Injection Pump:** Move the hand throttle to the half-open position.

3. Turn the starter key to its "HEAT" position, Figure 24, and hold for 30 seconds, then start the engine by turning the key to its "HEAT-START" position.

4. If the engine fails to start after 25 seconds of cranking, release the key and then return it to the "HEAT" position for an additional 15 seconds.

5. After the engine starts, release the key and reduce the throttle setting. The key will spring return to the "OFF" position. It must then be turned to the "ON" position for the warning lights to function.

**NOTE:** If the engine starts and then stops, make sure the excess fuel button is pushed "in" before attempting to restart the engine.

**Ether Spray Primer (Accessory):** The ether spray primer, Figure 25, is available as an accessory on Ford 2000, 2110, and 3000 Diesel Tractors. It can also be used on these same tractors in conjunction with the coolant immersion heater covered on page 16. The ether spray primer is effective in temperatures down to:

- 0° F. . . . . Ford 2110 and 3000 w/Select-O-Speed
- -10° F. . . . . Ford 2110 and 3000 w/Coolant Immersion Heater and Select-O-Speed
- -10° F. . . . . Ford 2000, 2110, and 3000 w/Manual Transmission



Figure 25  
Ether Spray Primer

## OPERATION

- -20° F. . . . . Ford 2000, 2110, and 3000 w/Coolant Immersion Heater and Manual Transmission



**CAUTION:** To avoid explosions in the manifold, ether must not be used with the automatic thermostart. Ether is highly combustible and serious personal injury may result.

**IMPORTANT:** Do not operate the tractor with the ether spray primer container removed, as dust can enter the intake manifold through the exposed opening. An empty container will seal the opening as well as a full container.

The spray primer is activated by the spray primer button, Figure 25. To start a cold diesel engine with the ether spray primer:

1. **Select-O-Speed Transmissions:** Depress the inching pedal and move the gear selector lever to the park (P) position.

**Manual Shift Transmissions:** Depress the clutch pedal and move the high-low shift lever to the neutral position.

2. **In-Line Injection Pump:** Move the hand throttle to the wide-open position. Push the excess fuel button "in" to increase fuel delivery, then reduce the throttle setting to the half-open position.

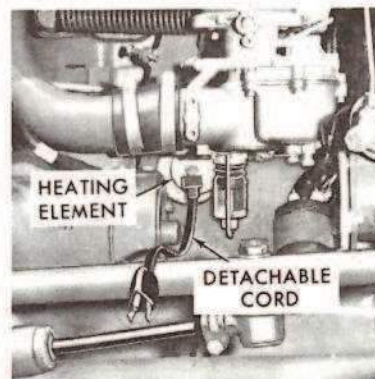
**Distributor Injection Pump:** Move the hand throttle to the half-open position.

3. Turn the starter key to the "START" position.
4. While the engine is cranking, depress the spray primer button, Figure 25, for one or two seconds.



**CAUTION:** Do not hold the primer button down longer than two seconds. If the engine does not start, purge it of ether by cranking for five seconds before depressing the button a second time. Make sure the excess fuel button is pushed "in" on the in-line injection pump before attempting to restart the engine.

**Coolant Immersion Heater (Accessory):** The coolant immersion heater, Figure 26, consists of a heating element installed in the right side of the engine block (two elements on the Ford 5000). A detachable cord is provided for plugging into an electrical outlet. A dust plug is also included for installation in the element when the cord is removed. The heater provides for easier starting in temperatures down to those listed below by warming the engine coolant and oil. The heater can also be used with the ether spray primer on Ford 2000, 2110, and 3000 Tractors as covered on page 15.



**Figure 26**  
**Coolant Immersion Heater**

- -10° F. . . . . Ford 2110 and 3000 w/Ether Spray Primer and Select-O-Speed
- -20° F. . . . . Ford 2000, 2110, and 3000 w/Ether Spray Primer and Manual Transmission
- -20° F. . . . . Ford 4000, 4000 SU, and 5000 w/Select-O-Speed and Manual Transmission

### To operate the heater:

1. Plug the heater cord into a 15 amp rated extension cord. (Ford 5000 requires a double outlet or two 8 amp rated extension cords).
2. Plug the cord into a 115 volt A.C. electrical circuit that is protected by a 15 amp fuse or circuit breaker.
3. Keep plugged in for up to eight hours, then start the engine as covered under "COLD WEATHER STARTING," page 14.

**NOTE:** The heater can be plugged in longer than eight hours without damage; however, there will be no noticeable increase in its effectiveness. Also, when the heater is not in use, store the heater cord in the tractor tool box to prevent its loss. Also install the dust plug.

## STOPPING THE ENGINE

### GASOLINE ENGINES

Turn the key-starter switch, Figure 24, to the "OFF" position.

### DIESEL ENGINES

Pull the diesel stop control out and hold until the engine stops, then turn the key-starter switch, Figure 24, to the "OFF" position.

**IMPORTANT:** Failure to turn the key-starter switch to the "OFF" position after the engine stops will result in the warning lights remaining on, causing the battery to discharge.

## OPERATING SELECT-O-SPEED TRACTORS AND P.T.O.

### SELECT-O-SPEED TRANSMISSION OPERATION

Gear ratios 1 through 4 are normally used for slow precise work or extremely heavy pulling; gear ratios 5 through 8 for medium speed field work; and gear ratios 9 and 10 for traveling at higher speeds on improved roads. When changing from the low range to the medium range (shifting from 4th to 5th), the change in speed is greater than from one gear ratio to another within a range.

The ten forward speeds overlap each other and provide speeds from 0.5 mph in first gear at 1000 rpm to approximately 17 mph at the maximum rated rpm in tenth gear (depending on the model tractor). The two reverse gear ratios provide approximately 1.5 mph in R<sub>1</sub> and approximately 5.1 mph in R<sub>2</sub>. Refer to the Tractor Ground Speed Charts, page 80.

For added convenience, the selector lever on your tractor can be mounted on either side of the speed selector mechanism to permit right- or left-hand shifting.

**To move the selector lever to the opposite side of the mechanism:**

1. Remove both covers from the gear selector mechanism, Figure 27.
2. Remove the gear selector lever from the shaft and position it on the opposite side of the selector mechanism.
3. Switch the covers and secure with the recessed head screws. Tighten securely.

**Starting Forward Travel:** With the engine running at low idle and the inching pedal depressed:

1. Shift directly to the desired gear ratio if the operation is anticipated to be in the low speeds (gear ratios 1 through 4). Shift to one gear below the anticipated operating gear for the higher gear ratios.

**NOTE:** When moving the lever through the neutral (N) position, apply light pressure outward on the lever, otherwise it will drop into the neutral locating notch.

2. Increase the throttle setting to handle the initial load, then let the inching pedal up slowly until the tractor moves off smoothly.
3. Shift on-the-go to the speed ratio that will permit the best performance, then move the throttle to the desired setting.

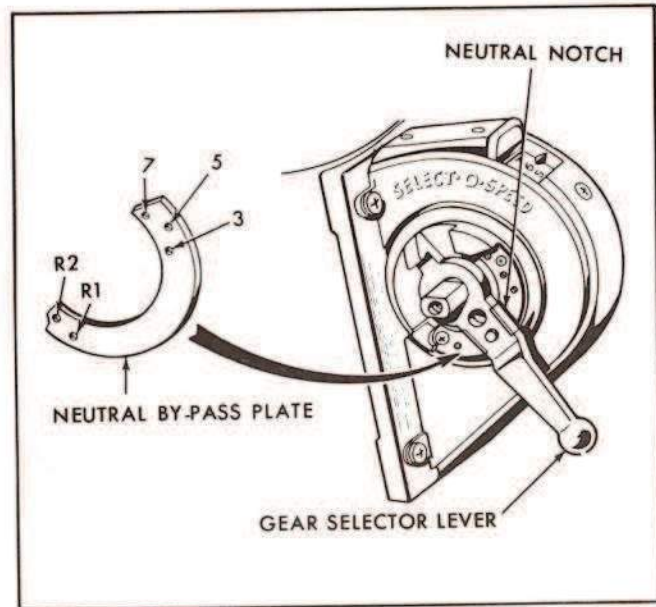


Figure 27  
Selector Lever Override Positions

**Shifting Select-O-Speed On-the-Go:** The following are suggested operating procedures:

1. Snap the selector lever quickly from gear to gear. **Do not use the inching pedal as a clutch.**
2. Shift up or shift down just as often as your load varies, maintaining a moderate engine speed and highest gear ratio.
3. Always downshift when the engine starts to lug.
4. Use the inching pedal for smooth starts, easy hook-up of equipment, and for emergency stops.

**IMPORTANT:** Do not let your foot rest on the inching pedal when operating the tractor and do not "inch" the tractor for extended periods; otherwise, serious transmission damage may result.

**Shuttle Shifting Select - O - Speed:** The recommended method of controlling the selector lever in shuttle work is quite different from the method suggested for conventional shifting on-the-go.

To assist the operator in this respect, tractors shipped from the factory have selector lever stops installed in the gear selector mechanism on the side opposite the lever. Moving the stops to the lever side of the mechanism enables the operator to establish a predetermined shift pattern between two gears. These stops are especially convenient for shuttle operations.

The stop screws can be positioned in any two of the gear positions, 3, 5, 7, R<sub>1</sub>, or R<sub>2</sub>, by inserting them in the holes shown in Figure 27. The stops can be overridden to

## OPERATION

obtain any gear by pulling outward on the spring-loaded gear selector lever and shifting to the desired gear. When the selector stops are not desired, the stop screws should be placed in the holes on the side opposite the gear selector.

The neutral bypass plate, shown in Figure 27, is available as an accessory from your Ford Tractor-Equipment Dealer. When operation of the Select-O-Speed transmission requires constant shifting between forward and reverse gear ratios (shuttle work), the neutral bypass plate can be installed with the stop screws to prevent the gear selector lever from snapping into the neutral position detent. This added convenience makes direction changes virtually a continuous operation.

### To install the stop screws and/or bypass plate:

1. Remove both covers from the gear selector mechanism, Figure 27.
2. Remove the gear selector lever from its shaft and the stop screws from the opposite side of the selector mechanism.
3. Install the stop screws in the side of the selector mechanism to which the gear selector lever is to be attached. If the neutral bypass plate is to be installed, attach it with the stop screws.
4. Place the gear selector lever on its shaft and install both covers. Secure the covers with the recessed head screws. Tighten securely.

### To shuttle the tractor:

1. To start forward, depress the inching pedal and grasp the selector lever, pulling it quickly towards you until the handle hits the preset stop. Then release the inching pedal smoothly.
2. To reverse the tractor, depress the inching pedal and stop the tractor with the brakes as you push the selector lever forward against the stop with the palm of your hand. Release the inching pedal smoothly. With practice you can improve your coordination and efficiency in all types of shuttle work.

### Stopping Select-O-Speed Tractors:

1. When operating in the high gear ratios, reduce the throttle setting and downshift the transmission using intermediate gears to slow the tractor's forward speed.



**CAUTION:** Avoid downshifting too quickly through a series of gears. A sudden ratio change will cause the tractor to slow down too abruptly.

2. Downshift the transmission to the neutral (N) position or depress the inching pedal, if desired.
3. Apply pressure evenly to both brake pedals. When the tractor comes to a complete stop, shift the selector lever to park (P) and shut off the engine before you get off the tractor.



**CAUTION:** The park (P) position locks the transmission to prevent movement of the tractor. This feature prevents the tractor from rolling when attaching equipment. However, if the drive line disconnect lever, Figures 33 and 34, is in the disconnect position, the tractor can roll and the wheels should be blocked or the brakes locked.

### SELECT-O-SPEED POWER TAKE-OFF OPERATION

The power take-off (P.T.O.) on your tractor transfers engine power to mounted or pull-type equipment, and to belt-driven equipment when the belt pulley accessory is used. Standard P.T.O. speeds are 540 ±10 rpm and 1000 ±25 rpm. Most P.T.O.-driven equipment is designed to operate at these speeds. The speeds are obtained when engine rpm, as read on the Proof-Meter, is set at the speed listed in the following chart.

#### ENGINE SPEEDS VS. P.T.O. SPEED

Transmission	Engine Speed (rpm)	P.T.O. Speed (rpm)
Standard Select-O-Speed — Ford 2110, 3000, 4000, and 4110 (Independent P.T.O.)	1800	540
Standard Select-O-Speed — Ford 5000 (Independent P.T.O.)	1900	540
Deluxe Select-O-Speed — Ford 3000, 4000, and 4110	1800 1950	540 1000

**P.T.O. Shafts:** The P.T.O. shaft on your tractor is the standard 6-spline, 1 $\frac{3}{8}$ -inch diameter shaft, Figure 28. The 6-spline shaft is used for 540 rpm P.T.O. operation only.

If your tractor is equipped with the Deluxe Select-O-Speed transmission, the 21-spline shaft, Figure 28, is also included as standard equipment for 1000 rpm P.T.O. operation.





21-SPLINE P.T.O. SHAFT  
1000 RPM



6-SPLINE P.T.O. SHAFT  
540 RPM

Figure 28  
P.T.O. Shafts

**To change from one shaft to the other :**

1. Remove the P.T.O. shaft cap, Figure 29.
2. Remove the recessed screw from the shaft with the wrench provided.
3. Pull the shaft from the tractor and install the other shaft.
4. Install the recessed head screw and tighten it securely.

**IMPORTANT:** The 21-spline shaft should only be used for equipment designed for 1000 rpm P.T.O. operation.

**P.T.O. Shield:** The P.T.O. shield, shown in the insert, Figure 29, is standard equipment on Ford Tractors that are equipped with a power take-off (P.T.O.). The shield serves as a supporting member for drive line shields used with pull-type P.T.O.-driven equipment, and provides for your safety. Always install the shield when using P.T.O.-driven equipment.

**Select-O-Speed Independent P.T.O. Operation:** Independent P.T.O. can be engaged, operated and disengaged whether or not the tractor is in motion. To operate the tractor P.T.O. at the standard speed of 540 rpm or 1000

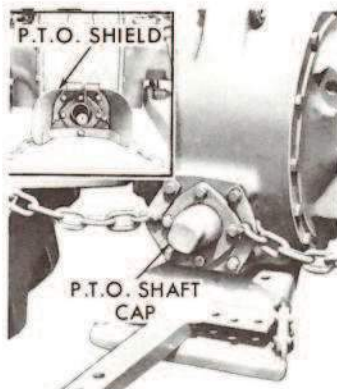


Figure 29  
P.T.O. Shaft Cap and Shield

rpm, the engine should be operated at the recommended speeds given in the chart on page 21. On Deluxe Select-O-Speed transmissions, the P.T.O. speed shift lever, Figure 30, must be positioned to give the desired P.T.O. speed. **Do not move the speed shift lever while the engine is running.** After determining the recommended engine speed and moving the speed shift lever:

1. Stop the engine, set the parking brake, and attach the mounted or drawn equipment. Make sure the equipment-driven shaft is properly aligned and locked to the tractor P.T.O. drive shaft. Also, make sure the 6-spline P.T.O. shaft, Figure 28, is installed when operating the P.T.O. at 540 rpm, or that the 21-spline shaft is installed for 1000 rpm P.T.O. operation.

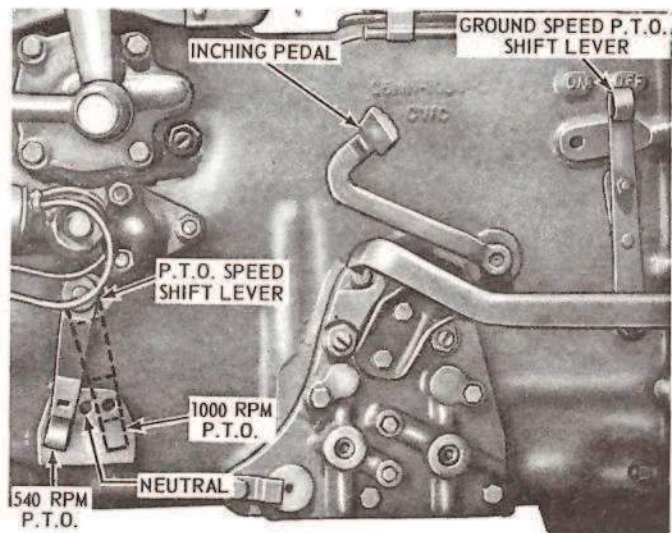


Figure 30  
Deluxe Select-O-Speed Controls

**CAUTION:** To reduce the possibility of personal injury and damage to the equipment, comply with the following before attaching or detaching P.T.O. equipment, and before working on or clearing P.T.O. equipment:



- Disengage the P.T.O. with the P.T.O. control handle. Figure 31 (Figure 32 on Ford 5000 Tractors).
- Move the gear selector lever to the park (P) position.
- Shut off the tractor engine.
- Wait until the P.T.O. shaft stops turning.

2. With the P.T.O. disengaged, start the engine and raise and lower mounted equipment to make sure proper clearance exists.

## OPERATION

3. With the engine throttle partially open, engage the P.T.O. as follows:

- Ford 2110, ... Pull the P.T.O. control handle, Figure 31, out slowly until the equipment drive shaft begins to turn. Then quickly pull the handle all the way out.
- Ford 3000, 4000, and 4110
- Ford 5000 ... Move the P.T.O. control lever, Figure 32, sharply rearward.

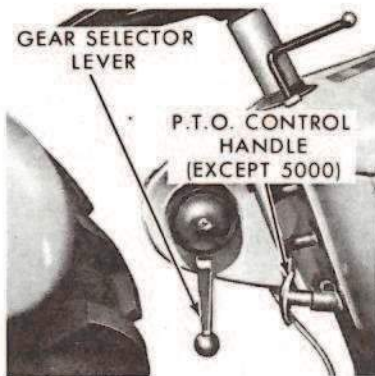


Figure 31  
Select-O-Speed Controls

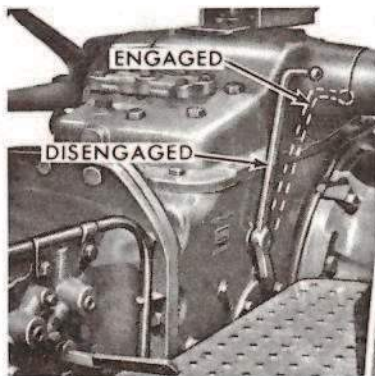


Figure 32  
Independent P.T.O. Control  
Lever—Ford 5000

**IMPORTANT:** When operating the P.T.O., make sure the P.T.O. control handle is always fully "out" (fully rearward on Ford 5000 Tractors). Partial engagement will cause the clutch to slip and may result in serious damage.

4. Operate the P.T.O. at low rpm making sure the P.T.O.-driven equipment is free of obstructions.

5. Before encountering the work, bring the P.T.O. speed up to the recommended rpm.

6. Select 1st gear ratio and enter the work with the P.T.O.-driven equipment at its operating speed as determined by the Proof-Meter. Gradually upshift on-the-go until the desired rate of forward travel is obtained.

7. If plugging, or the threat of plugging occurs, downshift to a lower gear ratio, to neutral if necessary, until the machine clears. If it becomes evident the machine will not clear, comply with the following before attempting to clear the equipment by hand.

- Disengage the P.T.O. with the P.T.O. control handle, Figure 31 (Figure 32 on Ford 5000 Tractors).
- Move the transmission gear selector lever to the park (P) position.
- Shut off the tractor engine.
- Wait until the P.T.O. shaft stops turning.

**NOTE:** After becoming familiar with the Select-O-Speed transmission, the operator can clear the machine by shifting directly to neutral (N) without depressing the inching pedal. This is done by applying force inward on the selector lever and pushing it hard against the neutral stop.

8. Disengage the P.T.O. when making sharp turns and with mounted equipment in the fully raised position.

9. Disconnect the P.T.O.-driven shaft at the tractor P.T.O. shaft before traveling on highways or for any great distance. Also, on Deluxe Select-O-Speed transmissions, move the P.T.O. speed shift lever, Figure 30, to the neutral position. Do not move the lever while the engine is running.

**Ground Speed P.T.O. Operation (Deluxe Select-O-Speed):** In such applications as raking, planting, spreading manure, etc., the ground speed P.T.O. will permit P.T.O.-driven equipment to be operated at a speed directly proportional to tractor ground speed.

The ground speed P.T.O. is engaged by moving the ground speed P.T.O. shift lever, Figure 30, to the "ON" position. When in the "ON" position, the P.T.O. shaft will turn only when the tractor is in motion; consequently, to ease into P.T.O. loads it will be necessary to use the inching pedal.

**NOTE:** Do not move the ground speed P.T.O. shift lever while the tractor is in motion.

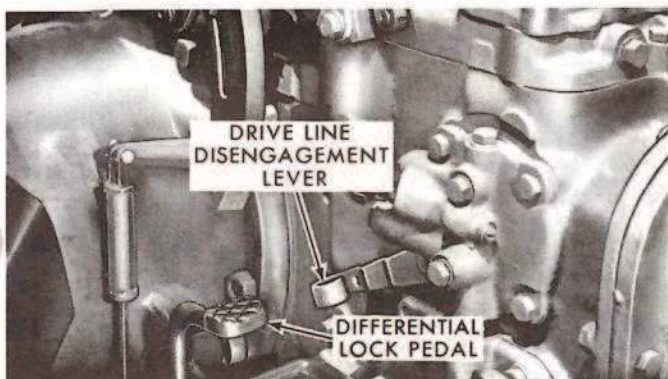
Make certain that the P.T.O. control handle, Figure 31, is pushed all the way in. A lock-out arrangement within the

**ENGINE SPEED AND GEAR SELECTION COMBINATIONS FOR GROUND SPEED P.T.O. WITH DELUXE SELECT-O-SPEED TRANSMISSION**

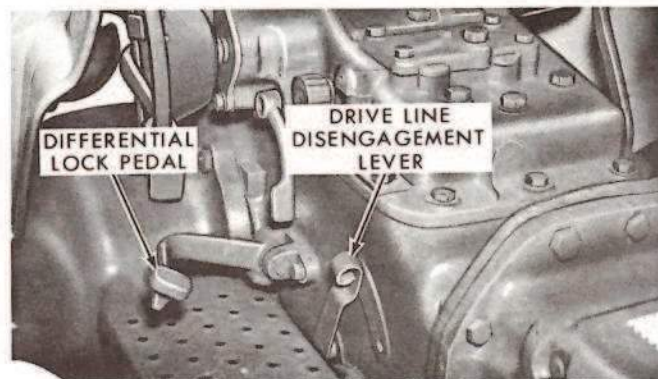
Ford 3000 and 4110	540 rpm (Ground Speed, 3.6 mph)				1000 rpm (Ground Speed, 6.7 mph)		
	Engine rpm	2067	1608	1398	1086	2011	1243
Gear Selection	5	6	7	8	8	9	10

Ford 4000	540 rpm (Ground Speed, 3.0 mph)				1000 rpm (Ground Speed, 5.5 mph)		
	Engine rpm	1708	1331	1154	898	1664	1027
Gear Selection	5	6	7	8	8	9	10



**Figure 33**  
Rear Axle Controls—All Models Except Ford 5000 (4000 Shown)



**Figure 34**  
Rear Axle Controls—Ford 5000

transmission prevents moving the ground speed P.T.O. shift lever if the handle is pulled out.

**IMPORTANT:** Before backing the tractor, the ground speed P.T.O. shift lever, Figure 30, must be moved to the "OFF" position. Failure to do this may result in serious damage to the equipment.

If the equipment is designed to operate at either 540 rpm or 1000 rpm, the Deluxe Select-O-Speed transmission provides for several combinations of gear ratios and engine speeds for operating in ground speed P.T.O. The chart at the top of this page illustrates the combinations available to obtain the 540 and 1000 rpm P.T.O. speeds with Ford 3000, 4000, and 4110 Tractors.

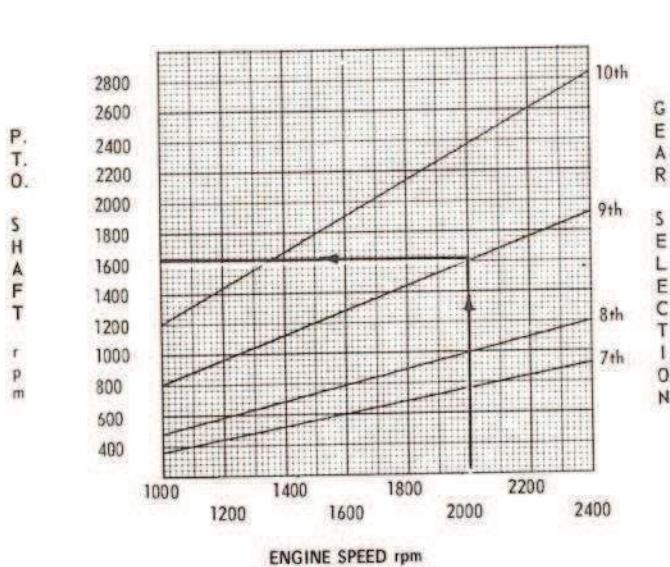
**Stationary P.T.O. Speeds in Excess of 1000 rpm (Deluxe Select-O-Speed):** To operate stationary P.T.O. equipment at speeds above 1000 rpm, comply with the following in the order listed.

1. With the engine stopped, apply the parking brake and block the tractor rear wheels both in front of the wheels and in back of the wheels.

2. Move the drive line disengagement lever, Figure 33, upward to disengage power to the rear wheels.
3. Push the P.T.O. control handle, Figure 31, all the way in, then move the ground speed P.T.O. shift lever forward to the "ON" position.
4. Depress the inching pedal, Figure 30. Start the engine and position the gear selector lever in 7th, 8th, 9th, or 10th.
5. Slowly release the inching pedal to start the P.T.O. shaft rotating.
6. Refer to Figures 35 and 36 for the P.T.O. speeds that can be obtained at various engine rpm's in 7th, 8th, 9th, or 10th gear. Note the examples shown.

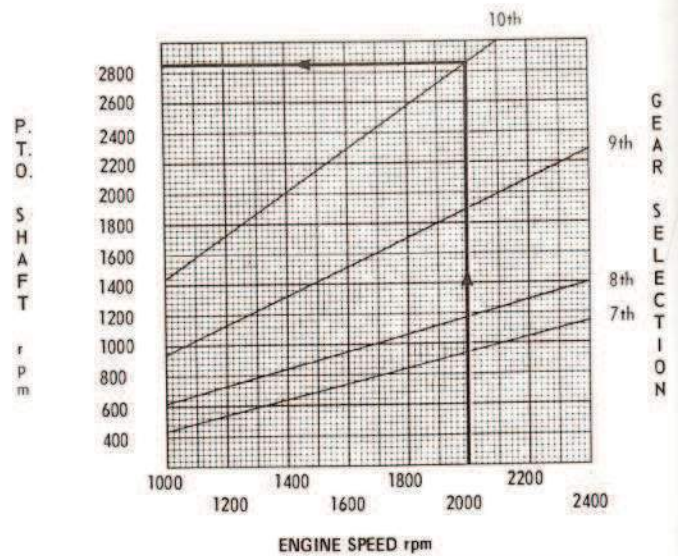
**IMPORTANT:** Do not use 1st, 2nd, 3rd, 4th, 5th or 6th for driving stationary P.T.O. equipment as described above, as it is possible to overload the P.T.O. in these gear ratios.

# OPERATION



EXAMPLE FORD 3000: 2000 ENGINE rpm IN 9th GEAR GIVES 1600 P.T.O. rpm

**Figure 35**  
P.T.O. RPM vs. Engine RPM in Ground Speed Drive  
(Ford 3000)



EXAMPLE FORD 4000: 2000 ENGINE rpm IN 10th GEAR GIVES 2857 P.T.O. rpm

**Figure 36**  
P.T.O. RPM vs. Engine RPM in Ground Speed Drive  
(Ford 4000)

**Select-O-Speed Stationary P.T.O. Operation:** To operate stationary P.T.O. equipment at 540 rpm or 1000 rpm, comply with the following in the order listed:

1. With the engine stopped, apply the parking brake and block the tractor rear wheels both in front of the wheels and in back of the wheels.
2. Position the gear selector lever, Figure 31, in the Park (P) position.
3. Move the drive disengagement lever, Figure 33, upward to disengage power to the rear wheels (forward on Ford 5000. See Figure 34.)
4. Start the engine and, with the throttle partially open, engage the P.T.O. in the normal manner as described under "Select-O-Speed Independent P.T.O. Operation," page 19.
5. Refer to the chart on page 21 for engine speed vs. P.T.O. speed.

### TOWING SELECT-O-SPEED TRACTORS

To tow or push your tractor, the drive line disengagement lever, Figures 33 and 34, must be moved to the disconnect position. To disconnect the drive line, the lever must be moved:

- Up ..... Ford 2110, 3000, 4000, and 4110
- Forward ..... Ford 5000



**CAUTION:** If the tractor is on a hill, block the rear wheels and apply the parking brake before moving the lever, otherwise the tractor is free to roll.

If the tractor is to be moved any distance, use a solid tow bar and pull the tractor at a speed not to exceed 20 mph. When the engine is not running, additional steering effort is required if your tractor is equipped with power assist steering. The engine cannot be started by pushing the tractor.

## OPERATING MANUAL SHIFT TRACTORS AND P.T.O.

### MANUAL SHIFT TRANSMISSION OPERATION

The 6- and 8-speed transmissions operate through the use of a clutch pedal, a gearshift lever, and a high-low shift. Figures 17 and 18 illustrate the pedal and levers involved. Ground speeds can be found on page 80.

Always depress the clutch pedal fully and bring the tractor to a complete stop before moving either gearshift lever. Do not attempt to change gears while the tractor is in motion.

**NOTE:** Avoid using the clutch pedal as a "footrest" (riding the clutch). Prolonged operation in this manner can cause damage to the components.

**6-Speed:** When the high-low shift lever is in the low range, 1st, 2nd, 4th, and low reverse gear ratios can be selected with the gearshift lever. When the high-low lever is in the high range, 3rd, 5th, 6th, and high reverse gear ratios can be selected.

**8-Speed:** When the high-low shift lever is in the low range, 1st, 2nd, 3rd, 4th, and low reverse gear ratios can be selected with the gearshift lever. When the high-low lever is in the high range, 5th, 6th, 7th, 8th, and high reverse gear ratios can be selected.

**To change from one gear ratio to another, or to change ranges:**

1. Depress the clutch pedal completely.
2. Bring the tractor to a complete stop.
3. Shift to the desired gear and/or range.

**MANUAL SHIFT POWER TAKE-OFF OPERATION**

The power take-off (P.T.O.) on your tractor transfers engine power directly to mounted or pull-type equipment, or to belt-driven equipment when the belt pulley accessory is used. The standard P.T.O. speed is 540 ± 10 rpm. Most P.T.O. equipment is designed to operate efficiently at this speed. The speed is obtained when engine rpm, as read on the Proof-Meter, is set at the speed listed in the following chart.

**ENGINE SPEED VS. P.T.O. SPEED**

Transmission	Engine Speed (rpm)	P.T.O. Speed (rpm)
6-Speed Ford 2000 and 3000 (Transmission P.T.O.)	1800	540
8-Speed Ford 2000 and 3000 (Transmission P.T.O.)	1600	540
8-Speed Ford 4000 (Transmission P.T.O.)	1800	540
6- and 8-Speed Ford 2000, 2110, 3000, and 4110 (Live P.T.O.)	1800	540
8-Speed Ford 4000 and 4000 SU (Independent P.T.O.)	1800	540
8-Speed Ford 5000 (Independent P.T.O.)	1900	540

**P.T.O. Shaft:** The P.T.O. shaft on your tractor is the standard 6-spline, 1 $\frac{1}{8}$ -inch diameter shaft, Figure 28. The 6-spline shaft is used for 540 rpm P.T.O. operation only.

**P.T.O. Shield:** The P.T.O. shield, shown in the insert, Figure 29, is standard equipment on Ford Tractors that are equipped with a power take-off (P.T.O.). The shield serves as a supporting member for drive line shields used with pull-type P.T.O.-driven equipment, and provides for your safety. Always install the P.T.O. shield when using P.T.O.-driven equipment.

**Transmission and Live P.T.O. Operation (Manual Transmission):** To operate the tractor P.T.O. at the standard speed of 540 rpm, the engine should be operated at the recommended speeds given in the above chart. After determining the recommended engine speed:

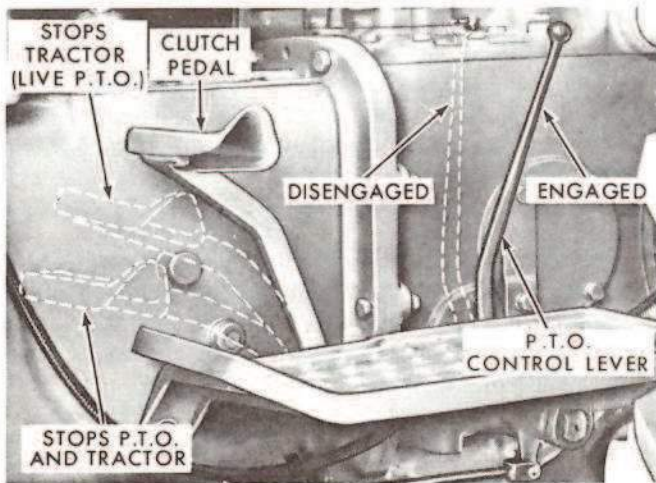
1. Stop the engine, set the parking brake, and attach the mounted or drawn equipment. Make sure the equipment-driven shaft is properly aligned and locked to the tractor P.T.O. drive shaft.



**CAUTION:** To reduce the possibility of personal injury and damage to the equipment, comply with the following before attaching or detaching P.T.O. equipment, and before working on or clearing P.T.O. equipment.

- Disengage the P.T.O. with the P.T.O. control lever, Figure 37.
  - Depress the clutch pedal completely and move the transmission High-Low shift lever to the Neutral (N) position.
  - Shut off the tractor engine.
  - Wait until the P.T.O. shaft stops turning.
2. With the P.T.O. disengaged, start the engine. In the case of mounted equipment raise and lower the equipment to make sure proper clearance exists.
  3. With the transmission in neutral, depress the clutch pedal completely, then engage the P.T.O. by moving the P.T.O. control lever, Figure 37, rearward.
    - 6- and 8-Speed .....Rearward
- NOTE:** Failure to move the P.T.O. lever through its full range may result in damage to the P.T.O.
4. Check the P.T.O.-driven equipment for proper operation by gradually releasing the clutch pedal and increasing engine rpm.
  5. After determining that the equipment is operating properly, depress the clutch pedal and shift to the desired operating gear. Release the pedal gradually to start the P.T.O. and tractor in motion.

## OPERATION



**Figure 37**  
Transmission and Live P.T.O. Control Lever and Clutch Pedal—6-Speed and 8-Speed

**NOTE:** On transmissions with live P.T.O., the required engine rpm can be obtained with the clutch pedal depressed halfway. On transmission P.T.O.-equipped tractors, engage the P.T.O. in advance of the work area so the engine rpm can build up to the required speed.

6. Control the P.T.O. speed with the throttle. If the tractor speed is too fast for the P.T.O. load, stop the tractor and shift to a lower gear.
7. **Live P.T.O.:** If plugging or the threat of plugging occurs, depress the clutch pedal halfway to stop the tractor. The machine will continue to operate and clear itself. If it becomes evident the machine will not clear, comply with the following before attempting to clear the equipment by hand.
  - Disengage the P.T.O. with the P.T.O. control lever, Figure 37.
  - Depress the clutch pedal completely and move the transmission gearshift levers to their neutral positions.
  - Shut off the tractor engine.
  - Wait until the P.T.O. shaft stops turning.
8. Disengage the P.T.O. with the P.T.O. control lever when making sharp turns and with mounted equipment in the fully raised position.
9. Disconnect the P.T.O.-driven shaft at the tractor P.T.O. shaft before traveling on highways or for any great distance.

**Independent P.T.O. Operation (Manual Transmission):** To use the tractor P.T.O. at the standard speed of 540 rpm, the engine must be operated at the recommended speed given in the chart on page 23.

Independent P.T.O. is hydraulically controlled through a clutch and can be engaged, operated, and disengaged whether or not the tractor is in motion. The P.T.O. is engaged and disengaged by the P.T.O. control lever, Figures 32 and 38.

**NOTE:** When the engine is not running or when the P.T.O. is disengaged, a mechanical brake prevents the P.T.O. shaft from turning.

After determining the recommended engine speed:

1. Stop the engine, set the parking brake, and attach the mounted or drawn equipment. Make sure the equipment-driven shaft is properly aligned and locked to the tractor P.T.O. drive shaft.



**CAUTION:** To reduce the possibility of personal injury and damage to the equipment, comply with the following before attaching or detaching P.T.O. equipment, and before working on or clearing P.T.O. equipment.

- Disengage the P.T.O. with the P.T.O. lever, Figures 32 and 38.
- Depress the clutch pedal and move the transmission gearshift levers to their neutral positions.
- Shut off the tractor engine.
- Wait until the P.T.O. shaft stops turning.



**Figure 38**  
Independent P.T.O. Control Lever—Ford 4000

2. With the P.T.O. disengaged, start the engine. In the case of mounted equipment, raise and lower the equipment to make sure proper clearance exists.
3. Engage the P.T.O. by moving the P.T.O. control lever, Figures 32 and 38, as follows:
  - Ford 4000 and 4000 SU Move the lever sharply forward
  - Ford 5000 . . . . . Move the lever sharply rearward

4. Operate the P.T.O. at low rpm to make sure the P.T.O.-driven equipment is free of obstructions.
5. Before encountering the work, bring the P.T.O. speed up to the recommended rpm.
6. Select the correct gear ratio and enter the work. If plugging or the threat of plugging occurs, depress the clutch pedal to stop the tractor. The implement will continue to operate and clear itself. If it becomes evident the implement will not clear, comply with the following before attempting to clear the equipment by hand.
  - Disengage the P.T.O. with the P.T.O. control lever, Figures 32 and 38.
  - Depress the clutch pedal and move the gearshift levers to their neutral position.
  - Shut off the tractor engine.
  - Wait until the P.T.O. shaft stops turning.
7. Disengage the P.T.O. with the P.T.O. control lever when making sharp turns and with mounted equipment in the fully raised position.
8. Disconnect the P.T.O.-driven shaft at the tractor P.T.O. shaft before traveling on highways or for any great distance.

**Stationary P.T.O. Operation (Manual Transmission):** To operate stationary P.T.O. equipment at the standard speed of 540 rpm, comply with the following in the order listed.

1. With the engine stopped, apply the parking brake and block the tractor rear wheels both in front of the wheels and in back of the wheels.
2. Position the gearshift lever, Figure 17, in 1st gear and the high-low shift lever in neutral.
3. With the P.T.O. disengaged, and the clutch pedal fully depressed, start the tractor engine.
4. **Transimssion and Live P.T.O.:** Engage the P.T.O. by moving the P.T.O. control lever, Figure 37, rearward, then gradually release the clutch pedal and increase engine rpm to ease into the P.T.O. load.
5. **Independent P.T.O.:** Release the clutch pedal and set engine rpm at idle; then engage the P.T.O. by moving the P.T.O. control lever, Figures 32 and 38, as follows:
  - Ford 4000 and 4000 SU. Move the lever sharply forward
  - Ford 5000. . . . . Move the lever sharply rearward
6. Refer to the chart on page 23 for engine speed vs. P.T.O. speed.

## TOWING MANUAL SHIFT TRACTORS

To tow or push your tractor, place the transmission gearshift levers in neutral. Do not exceed 20 mph. Do not tow or push your tractor to start it.

If the tractor is to be moved any great distance, use a solid tow bar and pull the tractor at a speed not to exceed 20 mph. When the engine is not running, additional steering effort is required if your tractor is equipped with power assist steering.

## OPERATING DIFFERENTIAL LOCK

On tractors equipped with differential lock, the lock is engaged by depressing the pedal located on the right side of the center housing, Figures 33 and 34. Depressing the pedal locks both rear axle shafts together, preventing one wheel from rotating independently of the other. The lock should be used to obtain additional traction from the opposite wheel whenever one wheel begins to slip in wet or loose soil.

Do not engage the differential lock when driving the tractor on the highway, or when ground speed is above 5 mph.



**CAUTION:** Do not engage the differential lock when turning the tractor. If the lock is engaged when turning, there could be a loss of steering control and injury to the operator could result.

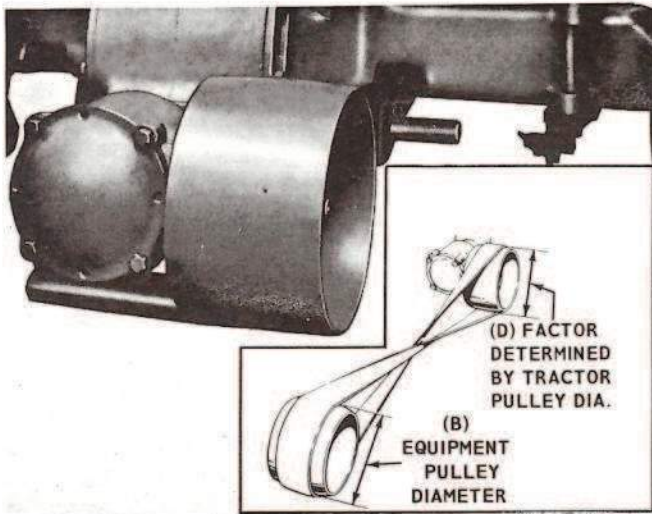
To operate the differential lock, depress and hold the pedal down until the lock is definitely felt to engage, then release the pedal. The lock will remain engaged until traction of both rear wheels is equal. It will then disengage automatically, and the pedal will return to its original position when traction equalizes. If a wheel spins at high speed, as on ice, reduce engine speed to idle before engaging the lock, or damage may occur.

**NOTE:** It is best to engage the differential lock while the wheels are turning slowly. This will minimize shock loads to the drive line.

## OPERATING BELT PULLEY (ACCESSORY)

The belt pulley, shown in Figure 39, is available as an accessory on Ford Tractors that are equipped with a 6-spline, 540 rpm P.T.O. shaft. The pulley can be installed

# OPERATION



**Figure 39**  
Belt Pulley Installed on Ford 3000 Tractor

horizontally to the left or right, giving clockwise or counter-clockwise pulley rotation. The pulley may also be installed in the downward position.

**NOTE:** Never install the pulley in the "UP" position.

**To install the pulley:**

1. Remove the P.T.O. shaft safety cap, the P.T.O. shield, the drawbar, the drawbar hanger, and the check chains.
2. Position and secure the pulley assembly over the 6-spline P.T.O. shaft with the four bolts previously used to secure the drawbar hanger.

**NOTE:** A belt pulley guard is available as an accessory from your Ford Tractor-Equipment Dealer.

For best performance, stationary machinery must be operated at the correct belt speed. The A.S.A.E. has established a standard for belt speeds of 3100 ± 100 fpm. A belt speed within this range is reached for various tractor transmissions using the pulley and engine speeds in the chart below. The last column in the chart lists factors for determining the proper diameter pulley to be used on the driven equipment.

Belt-driven equipment that does not meet A.S.A.E. standards should be operated at the speed recommended by the manufacturer. This speed can be obtained only with the proper equipment pulley diameter as determined by the formula:

$$B = \frac{D \times E}{A}$$

A = Desired equipment rpm (found in Equipment Operator's Manual)

B = Equipment (driven) pulley size in inches (to be determined)

D = Factor determined by tractor (driving) pulley size shown in the chart

E = Tractor engine speed selected

**For Example:**

- A corn sheller is to be operated at 800 rpm.
- Your tractor is a Ford 2000 with a 6-speed transmission.
- From the chart for the 9-inch pulley, the pulley-to-engine speed factor is 5.70.
- Considering the horsepower requirements of the sheller, you decide you want the tractor engine to operate at 1700 rpm while shelling corn.

**OBTAINING 3100 ± 100 FEET PER MINUTE BELT SPEEDS**

Tractor	Transmission	Pulley Size	Engine Speed	Factor*
Ford 2000 and 3000	6- and 8-Speed (Transmission P.T.O.)	9 in.	2000	5.70
Ford 3000	8-Speed (Live P.T.O.)	10¼ in.	2000	5.70
	Select-O-Speed	10¼ in.	2000	5.70
Ford 4000 and 4000 SU	8-Speed (Transmission P.T.O.)	10¼ in.	2200	5.63
	8-Speed (Independent P.T.O.)	10¼ in.	2200	5.63
	Select-O-Speed	10¼ in.	2200	5.63
Ford 5000	8-Speed (Independent P.T.O.)	11 in.	2100	5.75
	Select-O-Speed	11 in.	2100	5.75

\*Use only if equipment does not meet A.S.A.E. standards.



- Using the formula  $\frac{D \times E}{A}$ , solve for B (equipment-driven pulley size) as follows:

$$B = \frac{D \times E}{A}$$

$$B = \frac{5.70 \times 1700}{800}$$

$$B = \frac{9690}{800}$$

B = 12-inch pulley size

- Your solution is a 12-inch pulley on the sheller. However, if you do not have a 12-inch pulley but do have a 13-inch pulley, a different approach can be taken to find engine speed.
- Using the formula  $\frac{A \times B}{D}$ , solve for E (tractor engine speed) as follows:

$$E = \frac{A \times B}{D}$$

$$E = \frac{800 \times 13}{5.70}$$

$$E = \frac{10,400}{5.70}$$

E = 1825 tractor engine rpm

- Therefore, you can use the 13-inch pulley on the sheller and set the tractor engine speed at 1825 rpm (under load). You could also use a different size drive pulley on the P.T.O.; however, it would then be necessary to compute the P.T.O. and engine speeds for your particular application.

## OPERATING HYDRAULIC LIFT SYSTEM

By moving the hydraulic lift control lever, Figures 40, 41, and 42, the hydraulic system provides accurate, smooth, and instant hydraulic power for raising a wide variety of equipment whenever the engine is running. The system incorporates both position and draft control to better adapt the tractor to varying types of operating conditions.

### POSITION CONTROL

With the hydraulic selector lever, Figures 40, 41, and 42, in position control, the tractor hydraulic system will automatically maintain the selected height or depth of three-point linkage equipment in relation to the tractor.

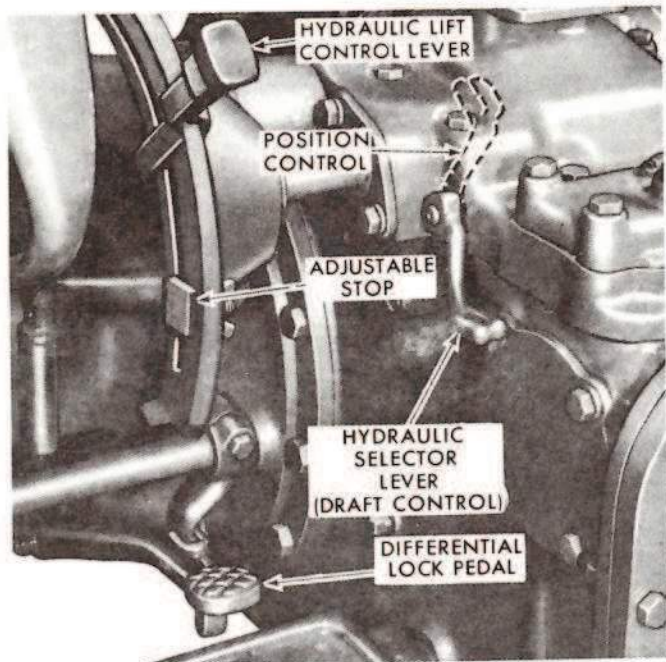


Figure 40  
Hydraulic Lift Controls—Ford 2000, 2110, and 4110

There is a definite relationship between the position of the hydraulic lift control lever and the position of the equipment. When the hydraulic lift control lever is moved to a higher or lower setting in the quadrant, the system immediately repositions the equipment to a higher or lower position. The system will then immediately maintain the selected position.

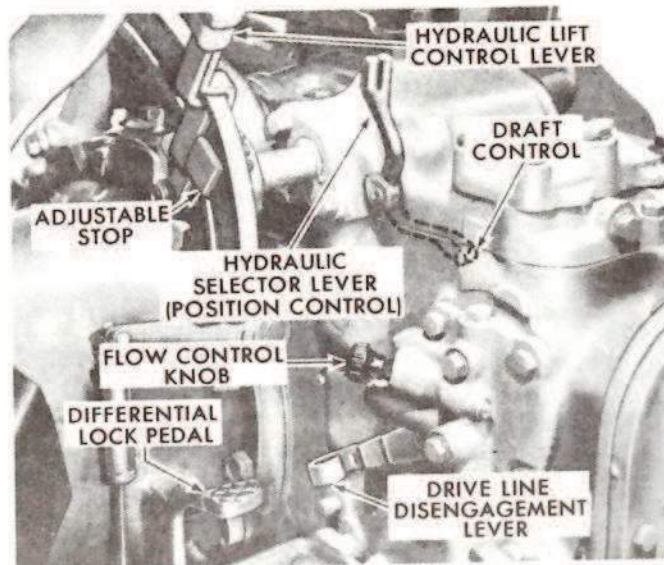


Figure 41  
Hydraulic Lift Controls—Ford 3000, 4000, and 4000 SU  
(Ford 4000 Shown)

## OPERATION

Position control provides easy, accurate control of three-point linkage equipment that operates above the ground, such as sprayers, rakes, mowers, etc. It is also an advantage when using blades or similar equipment on level ground, as it will maintain a more uniform depth.

### DRAFT CONTROL

When the hydraulic selector lever, Figures 40, 41, and 42, is in draft control, the tractor hydraulic system will automatically adjust the equipment's working depth to maintain an even pull on the tractor regardless of the soil conditions.

**Upper Link Compression Loads:** As the equipment is pulled through the soil, the draft caused by soil resistance has the effect of trying to rotate the equipment around the lower link hitch points. This draft creates a pushing or compressive force on the upper link. When changes in soil resistance cause the draft to increase or decrease, the compression force on the upper link will also increase or decrease. These changes in upper link compression will signal the hydraulic system, through internal linkage, to raise or lower the equipment, thereby maintaining uniform draft.

**Upper Link Tension Loads (Ford 3000, 4000, 4000 SU, and 5000):** When working with long, heavy equipment in light soils or at shallow depths, the soil resistance is not always sufficient to create a compressive force on the upper link. At times the link will be in tension. The hydraulic system on Ford 3000, 4000, 4000 SU, and 5000 Tractors will automati-

cally respond to tension as well as compression, thereby controlling working depth, even when using long, heavy equipment.

**NOTE:** When grading and backfilling with light equipment, such as a rear blade, it may be necessary to "block out" upper link tension loads on Ford 3000 and 4000 Tractors to prevent the blade from "diving." This is accomplished by installing a spacer (available from your Ford Tractor-Equipment Dealer) between the counterbore in the draft control main spring housing and the spring seat. See Figure 138. Response to upper link tension cannot be "blocked out" on Ford 5000 Tractors. Refer to page 73 for spacer installation instructions.

### FLOW CONTROL

#### Ford 3000, 4000, 4000 SU, and 5000

The flow control knob, Figures 41 and 42, provides an adjustment to regulate the oil flow rate used to move the lift piston in the hydraulic system, thus speeding up or slowing down the rate of lift. Flow control will affect the rate of lift in either draft or position control; it also affects the movement rate of remote cylinders.

When operating in draft control, the setting of the flow control knob regulates the hydraulic system responses by slowing down the draft reactions. This action permits attached equipment, such as a plow, to respond more quickly or slowly to soil texture changes. Turning the knob "in" speeds up the response. Turning the knob "out" slows down the response and provides more gradual hydraulic system reactions. In hard soils, and at moderate-to-fast tractor speeds, turning the knob "out" will improve quality of the work.

When the hydraulic lift control lever is raised to the top of the quadrant to raise the equipment, flow control is overridden and maximum lift speed is obtained.

### AUXILIARY SERVICE CONTROL VALVE

The auxiliary service control valve knob, Figures 42 and 43, permits the use of hydraulic power for single-acting remote cylinder operation. When operating in auxiliary control, it is recommended that the hydraulic selector lever, Figures 40, 41, and 42, be in draft control. The auxiliary service control valve knob positions are:

- Ford 2000, 2110,  
3000, 4000, 4000 SU,  
and 4110 . . . . . Full "in" to operate lift linkage.  
. . . . . Full "out" to operate remote cylinders.

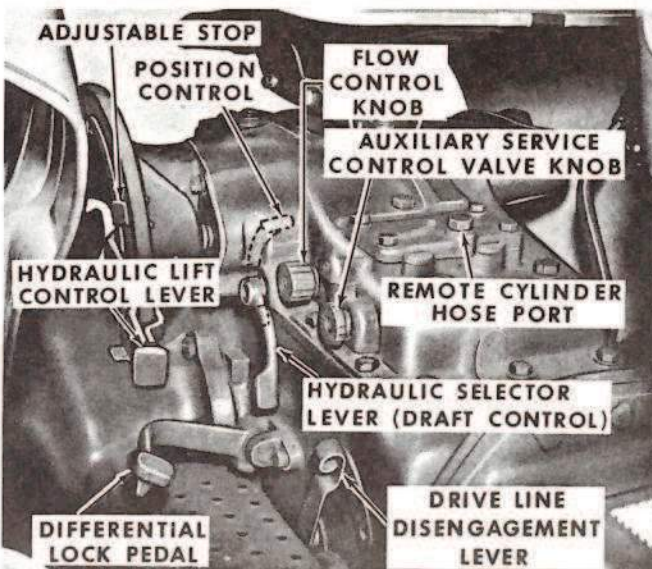


Figure 42  
Hydraulic Lift Controls—Ford 5000

- ..... Half "out" to operate lift linkage and remote cylinders simultaneously.
- Ford 5000 ..... Full "in" to operate lift linkage.
- ..... Full "out" to operate remote cylinders.



**Figure 43**  
Auxiliary Service Control Valve Knob—All Models Except Ford 5000

**NOTE:** With the exception of the Ford 5000, the auxiliary service control valve cannot be used with remote control valves. The Ford 5000 Tractor hydraulic lift system and remote cylinder (single-acting) can be operated simultaneously by connecting the remote cylinder hose directly into the lift cylinder through the remote cylinder port on the accessory cover. See Figure 42. Simultaneous operation does, however, depend on the amount of weight that is to be lifted by the lift links and remote cylinder. If the weight to be lifted by the cylinder is greater than the weight on the lift links, the links will raise to the top of their travel, making the hydraulic system inactive.

The actual operation of the remote cylinder is controlled by the hydraulic lift control lever, Figures 40, 41 and 42. With the engine running:

1. Move the hydraulic lift control lever to the neutral position in the quadrant, where neither raising nor lowering takes place.
2. Position the stop on the quadrant at the front edge of the lever. This will make it easy to quickly locate neutral.
3. Move the auxiliary service control valve knob to the full "out" position.
4. To extend the remote cylinder, move the control lever above its neutral position. When the cylinder is fully

extended, return the control lever to the neutral position to avoid "popping" the hydraulic system relief valve.

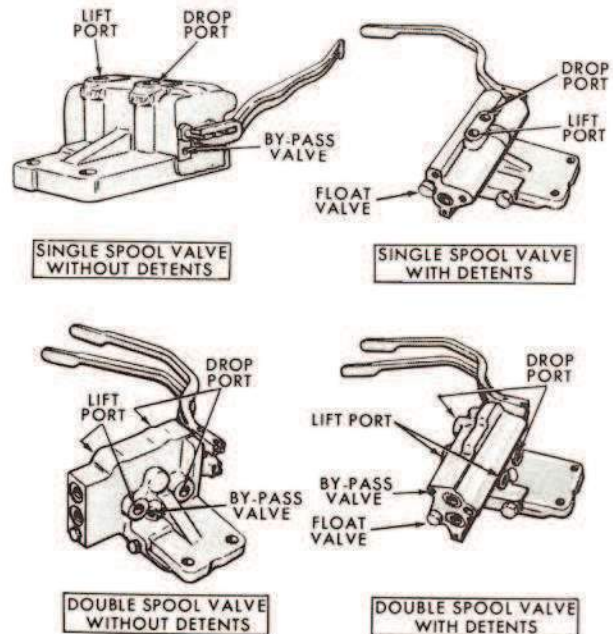
5. To retract the cylinder, move the control lever below the neutral position on the quadrant. The weight of the implement will retract the cylinder. When the cylinder is fully retracted, return the control lever to neutral.

**NOTE:** Remote cylinders are operated by oil initially drawn from the rear axle. Any remote cylinder that is disconnected when extended represents a loss of oil in the rear axle. This oil must be replaced by adding a corresponding quantity of oil. Also, all hoses should be cleaned before connecting, and the when not in use.

#### REMOTE CONTROL VALVES (OPTIONAL)

Your Ford Tractor can be equipped with a single- or double-spool remote control valve, with or without detents. See Figure 44. The detents hold the control handle(s) in the raise or drop position until the remote cylinder reaches the end of its stroke. The control handle then automatically returns to the neutral position.

Moving the handle(s) forward will lower the equipment; moving the handle(s) rearward will raise the equipment. See Figure 45.



**Figure 44**  
Remote Control Valves

# OPERATION

## REMOTE CONTROL VALVES

Control Valve Type	Cylinder Application(s)	Float Valve	Bypass Valve	Hose Installation*			
				Single-Spool Valves or Lower Spool of Double-Spool Valves		Upper Spool of Double-Spool Valves	
				Lift Port	Drop Port	Lift Port	Drop Port
Single-Spool Without Detents	One Double-Acting	N/A	Closed	Lift Hose	Drop Hose	N/A	N/A
	One Single-Acting	N/A	Open	Lift Hose	Plug	N/A	N/A
Single-Spool With Detents	One Double-Acting	Closed	N/A	Lift Hose	Drop Hose	N/A	N/A
	One Single-Acting	Open	N/A	Lift Hose	Plug	N/A	N/A
Double-Spool Without Detents	Two Double-Acting	N/A	Closed	Lift Hose	Drop Hose	Lift Hose	Drop Hose
	One Double-Acting One Single-Acting	N/A	Open	Lift Hose	Plug	Lift Hose	Drop Hose
	Two Double-Acting	Closed	Closed	Lift Hose	Drop Hose	Lift Hose	Drop Hose
Double-Spool With Detents	One Double-Acting One Single-Acting	Open	Closed	Lift Hose	Plug	Lift Hose	Drop Hose
	Two Single-Acting	Open	Open	Lift Hose	Plug	Lift Hose	Plug

**NOTE:** When installing the hoses to the control valve, install O-ring seals as shown in the insert, Figure 45.

\* Refer to Figure 44 for port locations.

N/A — Does not apply.

The remote control valves incorporate bypass and float valves that control the operation of the remote cylinders. These valves are covered in the paragraphs that follow. The chart above lists the cylinder combinations that can be used with the remote valves. The chart indicates when to open or close the bypass valve and/or float valve, and shows which ports to plug or connect hoses to for the various cylinder applications. Use the chart in conjunction with Figure 44.

**Bypass Valve:** The bypass valve provides an escape for hydraulic oil when a single-acting cylinder reaches the end of its stroke. Close the valve when using a double-acting cylinder. To close the valve, use an Allen wrench and turn the bypass screw clockwise until it "bottoms."

To open the valve for single-acting cylinders back the screw full "out."

**Float Valve:** The float valve should always be open when using a single-acting cylinder to provide an escape for

hydraulic oil at the plugged port when the cylinder is being retracted. The valve can be either open or closed when using a double-acting cylinder. An open valve allows the equipment to "float," or follow the ground contour. A fully closed valve will hold the equipment in a fixed position determined by the degree of cylinder extension.

To close the valve, turn the adjusting knob clockwise. To open the valve, turn the knob counterclockwise. Various degrees of down pressure or "float" can be achieved by partly opening or partly closing the valve.

**Detents:** Because the detents permit the remote cylinder(s) to extend or retract until they have reached the end of their stroke, it may be desirable to make the detents inoperative. This is accomplished by removing the springs, Figure 46. With the detent springs removed, the remote cylinders will stop their movement when the handles are released.

**IMPORTANT:** Do not remove the pistons. Remove only the springs.

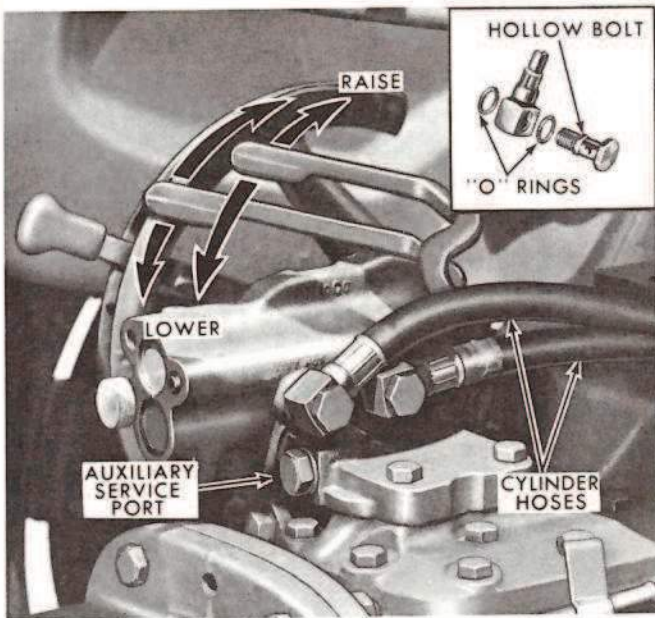


Figure 45  
Remote Control Valve Installed

**Remote Cylinder Coupling Kits (Accessory).** Your Ford Tractor can be equipped with remote cylinder coupling kits (available from your Ford Tractor-Equipment Dealer) which permit easy connection of hoses for remote cylinder applications.

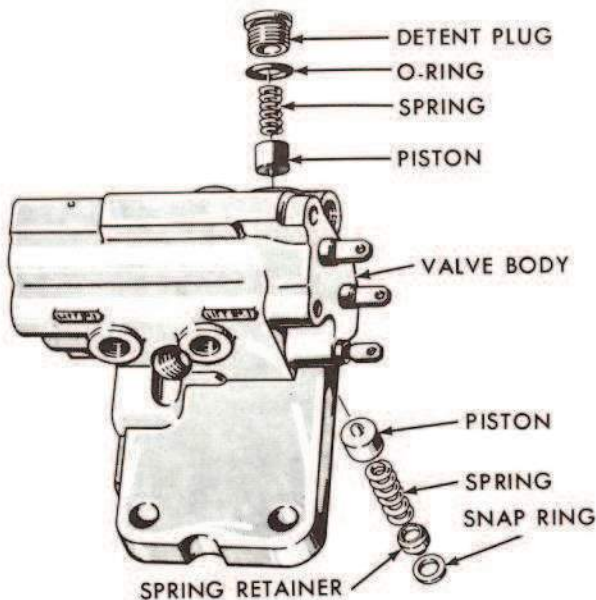


Figure 46  
Detent Spring Removal

#### To connect the couplings:

1. Shut off the tractor engine and relieve pressure or set the remote valve in "float."
2. Remove the dust cap. Make sure the hose end and the coupling housing are clean.
3. Pull the lever toward the rear. Insert the coupling into the coupling housing and release the lever.

#### To disconnect the couplings:

1. Shut off the tractor engine and relieve pressure or set the remote valve in "float."
2. Grip the hose firmly and pull the lever toward the rear. Remove the coupling from the coupling housing.
3. Cover the opening in the coupling housing with the dust cap.

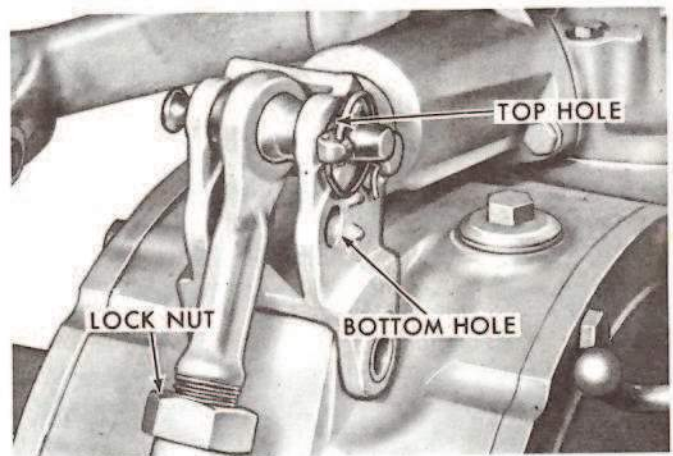


Figure 47  
Hydraulic Lift Rocker—Ford 2000, 2110, 3000, and 4110  
(Ford 3000 Shown)

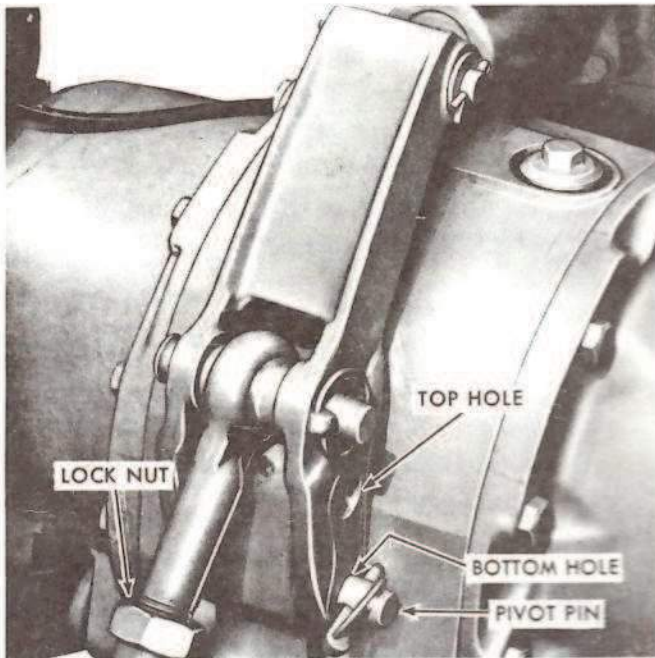
## LIFT LINKAGE AND DRAWBAR

### TRACTOR HYDRAULIC LIFT ROCKER

**Ford 2000, 2110, 3000, and 4110:** The hydraulic lift rocker, Figure 47, incorporates two holes for attaching the upper link. Attach the link in the top hole, as shown, for light draft loads (cultivating) and in the bottom hole for heavier draft loads (plowing).

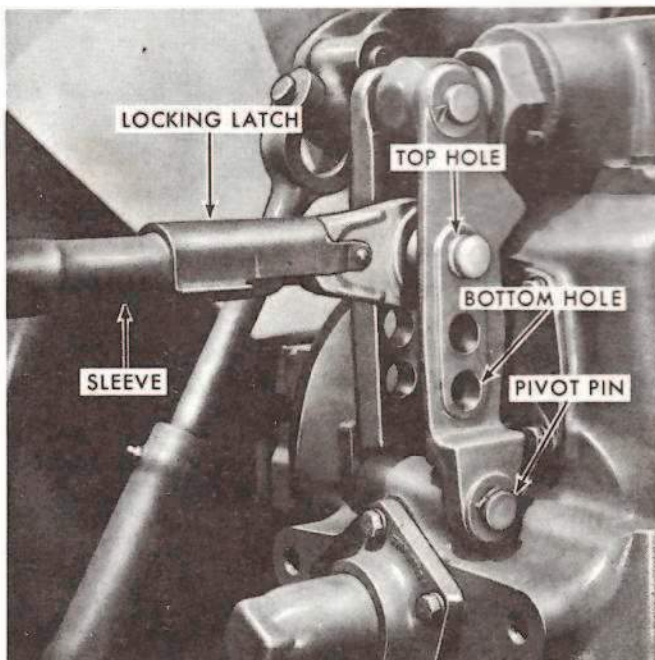
**Ford 4000 and 4000 SU:** The hydraulic lift rocker, Figure 48, incorporates two pivot pin holes. Install the pivot pin in the top hole for heavy draft loads (plowing), and in the bottom hole, as shown, for light draft loads (cultivating).

## OPERATION



**Figure 48**  
Hydraulic Lift Rocker—Ford 4000 and 4000 SU

**Ford 5000:** The hydraulic lift rocker, Figure 49, incorporates three holes for attaching the upper link. Attach the link in the top hole, as shown, for light draft loads (cutting), and in the bottom two holes for progressively heavier draft loads (plowing).



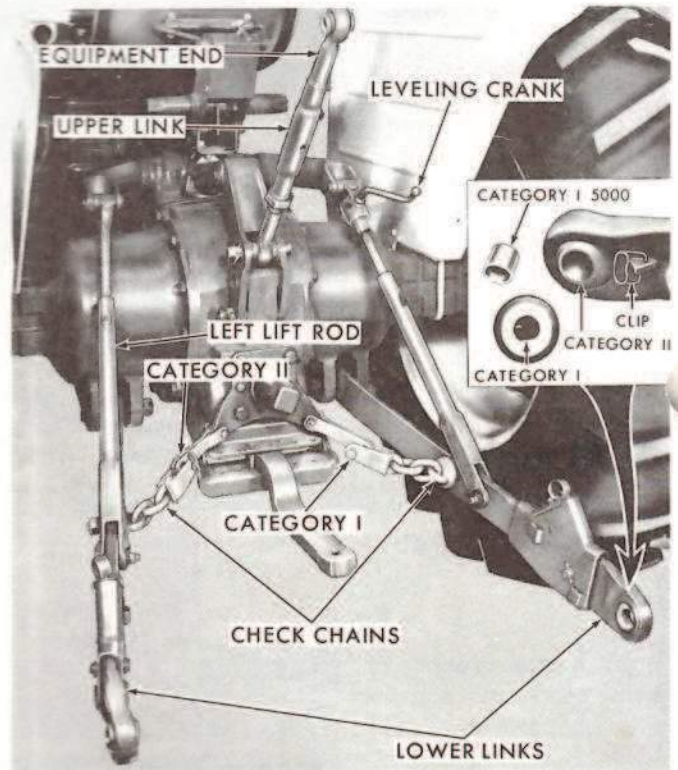
**Figure 49**  
Hydraulic Lift Rocker—Ford 5000

### CATEGORY I AND II LINKAGE

**Ford 2000, 2110, 3000, 4000, 4000 SU, and 4110:** These tractors are factory equipped with Category I Linkage, insert, Figure 50. Category II balls are available as an accessory for the Ford 3000, 4000, and 4000 SU only.



**CAUTION:** Even though Category II linkage is available for the Ford 3000, it is recommended that only light Category II equipment be used on this tractor. Heavy Category II equipment may impair tractor stability.



**Figure 50**  
Lift Linkage—Ford 4000 with Flexible Links Shown

To change from one category to another:

**Ford 5000:** The Ford 5000 Tractor is factory equipped with Category II Linkage, insert, Figure 50. Category I bushings are available as an accessory.

**Ford 3000, 4000, and 4000 SU:**

1. Remove the equipment end of the upper link, Figure 50, and install the alternate section.
2. Pull the spring-loaded retainer clip, insert, Figure 50 away from the link ball in each link, then rotate the balls until their holes are in a vertical position. The balls can then be removed and the alternates installed.

- When Category II linkage is used, adjust the check chains, Figure 50, to give their greatest length by attaching them to the tractor at the Category II hole. When using Category I linkage, shorten the chains by attaching them at the Category I hole as shown.

**NOTE:** This chain adjustment on Ford 3000 and 4000 SU Tractors is at the opposite end of the chains.

#### FORD 5000:

- Install the Category I bushings, insert, Figure 50, in the equipment end of the upper link and in the lower link balls.
- Install the new check chains and bracket provided. Adjust the chains to their shortest length for Category I, and to their longest length for Category II operation.

#### FLEXIBLE LINK ENDS

##### Ford 4000 and 5000

Flexible link ends, Figure 51, provide for quick and easy attachment of most equipment by permitting the link ends to move "up" and "down", and "in" and "out". Pulling the ring will release the link ends for this movement. Once the equipment is attached, the flexible links will lock in place and become rigid by simply inching the tractor rearward. Refer to page 35 for attaching equipment information.

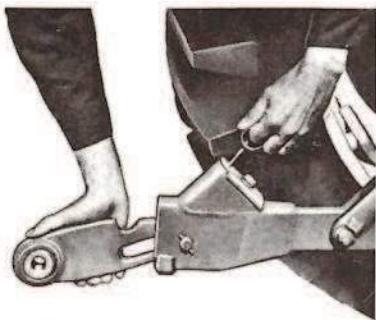


Figure 51  
Flexible Link Ends

#### STABILIZERS (ACCESSORY)

Stabilizer kits are available as an accessory from your Ford Tractor-Equipment Dealer. The stabilizers prevent equipment from swaying side to side which means better control. This is especially important when operating on slopes or near fences, walls, or ditches, and with certain implements. Check your Implement Operator's Manual. The kits are installed as follows:

**Ford 2000, 3000, and 4110:** The stabilizer kit is shown in Figure 52. The kit is identical for each tractor with the exception of the stabilizer links. Links 8 and 10 are for Ford 2000, 2110, and 4110 Tractors with Category I linkage. Links 5 and 11 are for Ford 3000 Tractors with Category I or II linkage.

#### To install the kit:

- Replace the existing fender bolts with the carriage bolts in the kit (3). Attach the fenders and stabilizer brackets (6) and (9) with the carriage bolts, nuts, and flat washers. Do not tighten at this time. Make sure the brackets are installed so the vertical side is inboard.
- Install one pivot pin (7) in each bracket and secure with the nut and lock washer (1) and (2). Do not tighten at this time. Make sure the large end of each pin is inboard.
- Position the links (8) and (10), or (5) and (11), over the pivot pins and retain them with the linch pins (4).
- Attach the equipment to the three-point linkage, then tighten all nuts securely.

**NOTE:** Use the lower hole in the links (5) and (11), when attaching Category II equipment. The upper hole is for Category I equipment. Adjust the check chains to the shortest length for Category I equipment and lengthen them for Category II equipment.

**Ford 4000 and 4000 SU:** The stabilizer kit for the Ford 4000 Tractor with flexible link ends is shown installed in Figure 53. The kit for the Ford 4000 SU Tractor with rigid link ends is the same as the Ford 4000 kit except for the stabilizer links (5). The SU Tractor uses the same links as the Ford

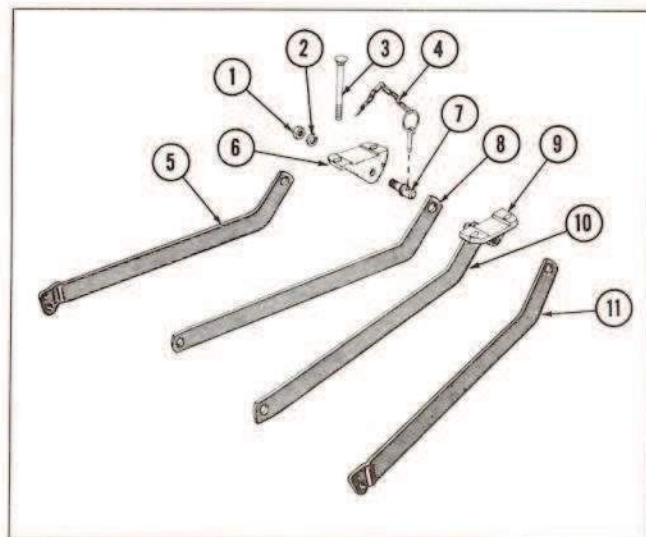
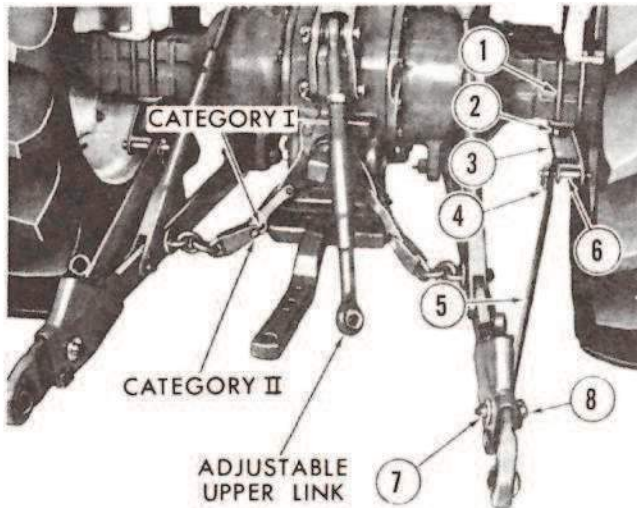


Figure 52  
Stabilizer Kit—Ford 2000, 2110, 3000, and 4110 (Accessory)

## OPERATION



**Figure 53**  
Stabilizer Kit—Ford 4000 with Flexible Links (Accessory)

3000. See (5) and (11), Figure 52. Either kit can be used with Category I or II linkage.

### To install the kit:

1. Attach the stabilizer brackets (3), Figure 53, to the rear axle with the U-bolts (1), and nuts and lock washers (2). Do not tighten at this time. Make sure the U-bolts are seated in the second groove of the axle and that the brackets angle rearward and toward the tires as shown.

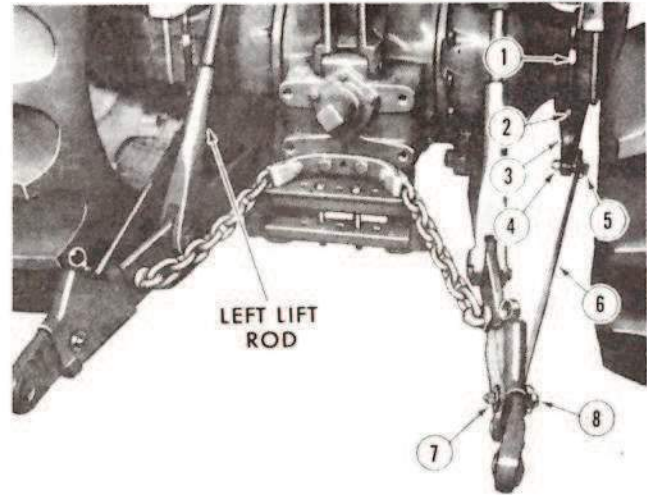
**NOTE:** Some stabilizer brackets are shaped different than those shown at (3), Figure 53. If the brackets for your stabilizer kit are different than those shown, make sure they are installed so they angle rearward and so the straight sides are next to the tires.

2. Install the stabilizer pins (6), then place the stabilizer links (5) over the pins and install the linch pins (4).

**NOTE:** When Category II equipment is used with the flexible link end stabilizer kit on the Ford 4000, attach the stabilizer links (5) to the brackets (3) so the pins (6) go through the upper hole in the links. The lower hole is for Category I equipment. Adjust the check chains to the shortest length for Category I equipment and lengthen them for Category II equipment.

Category I and II holes for the Ford 4000 SU Tractor are at the opposite end of the links. See (5) and (11), Figure 52. The upper hole is for Category I; the lower hole is for Category II.

3. **Ford 4000.** Remove the existing pins (8), Figure 53, and attach the stabilizer links (5) to the link ends with the pins (8) and nuts and washers (7) that are provided. Do



**Figure 54**  
Stabilizer Kit—Ford 5000 with Flexible Links

not tighten at this time. Secure the stabilizer links in place with the linch pins provided.

4. Attach the equipment to the three-point linkage; then tighten all nuts securely.

**Ford 5000:** The stabilizer kit for the Ford 5000 Tractor with flexible link ends is shown installed in Figure 54. The kit can be used with Category I or II linkage.

### To install the kit:

1. Attach the stabilizer brackets (3), Figure 54, to the rear axle with the U-bolts (1), and nuts and washers (2). Do not tighten at this time. Make sure the U-bolts are seated in the first groove of the axle and that the brackets angle rearward as shown.
2. Install one pivot pin (5) in each bracket and secure with the nut and washer (4). Do not tighten at this time. Make sure the large end of each pin is outboard as shown.
3. Position the stabilizer links (6) over the large end of the pivot pins (5) and retain them with the linch pins.

**NOTE:** When Category II equipment is used with the flexible link end stabilizer kit, attach the stabilizer links (6) at the upper hole. The lower hole is for Category I equipment.

4. Remove the existing pins (8) and attach the stabilizer links (6) to the link ends with the pins (8) and nuts and washers (7) that are provided. Do not tighten at this time. Secure the links in place with the linch pins provided.

**NOTE:** Make sure the longer check chains are used for Category II equipment and the short chains for Category I equipment.



- Attach the equipment to the three-point linkage; then tighten all nuts securely.

### ADJUSTABLE UPPER LINK

The adjustable upper link, Figure 53, on Ford 2000, 2110, 3000, 4000, 4000 SU, and 4110 Tractors can be adjusted to suit attached equipment by loosening the lock nut, Figures 47 and 48, and turning the sleeve as required. The link on Ford 5000 Tractors, Figure 49, is adjusted by lifting the locking latch and then turning the sleeve.

Most equipment will operate at the proper height when the upper link is adjusted to a length of approximately 27 inches as measured to the center of the attaching points.

### LIFT RODS AND LEVELING CRANK

**Ford 2000, 2110, and 4110:** The left lift rod, Figure 50, is preset at 21.5 inches and cannot be adjusted.

**Ford 3000, 4000, 4000 SU, and 5000:** The left lift rod, Figure 50, can be adjusted by removing the attaching bolt from the lower end of the rod and then turning the rod as required. For normal operation the rod should be adjusted to a length of:

- Ford 3000 ..... 23 inches
- Ford 4000 ..... 29.8 inches
- Ford 4000 SU ..... 28.75 inches
- Ford 5000 ..... 28.5 inches

The right lift rod is adjusted with the leveling crank, Figure 50. Use the crank to level attached equipment. Turning the crank to the right will shorten the lift rod, raising the equipment. Turning the crank to the left will lengthen the rod, lowering the equipment.

### SWINGING DRAWBAR

The swinging drawbar, Figure 55, permits quick, easy attachment to pull-type equipment. On tractors equipped with the Deluxe Select-O-Speed transmission, it can be

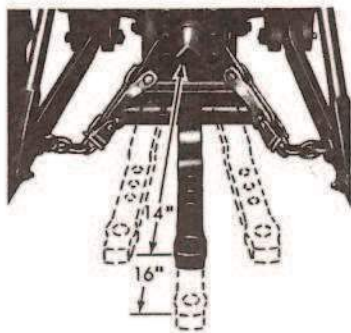


Figure 55  
Swinging Drawbar

used in either the 14-inch or the 16-inch extended position (measured from the end of the P.T.O. shaft). When operating 540 rpm P.T.O.-driven equipment, set the drawbar at the 14-inch position. Set it at the 16-inch position for 1000 rpm P.T.O. operation.

The drawbar may also be set and used in positions to the left or right of center (seven in all). Figure 55 shows some of the positions at which it can be set. Always lock the drawbar in place to prevent the equipment from swaying side to side.

### ATTACHING EQUIPMENT

Most equipment can be easily attached to the three-point linkage of your new Ford Tractor as follows:

- Back the tractor to a point where the lower link ends are touching or near the attaching pins of the equipment.
- Flexible Links:** Release the left-hand flexible link end by pulling on the ring, Figure 51.
- Position the left-hand ball over the attaching pin and secure it with a linch pin.
- If necessary, use the leveling crank, Figure 50, to position the right-hand link near the attaching pin. Then position the right-hand ball over the pin and secure it with a linch pin.
- Flexible Links:** Use the leveling crank and the hydraulic lift control lever to position the links so the link ends and links are properly in line for telescoping.
- Flexible Links:** Inch the tractor back until the link ends snap into place, locking themselves.
- Attach the upper link.

**IMPORTANT:** Before transporting or operating the equipment, observe the rear links to make sure the flexible assemblies are locked in the closed position. Also when attaching close-mounted equipment to the tractor, remove the drawbar.

## WHEEL TREAD SETTINGS

### FRONT WHEEL TREAD SETTINGS

The front wheel tread settings on Ford Tractors are adjustable in approximately 4-inch increments. See Figures 56 and 57. Tread settings for the various tractors are as follows:

**Ford 2000 and 3000:**

- 52 to 80 inches with 5.50-16 or 6.00-16 tires

# OPERATION

## Ford 2110 and 4110:

- 54 to 78 inches with 6.50-13 tires
- 60 to 76 inches with 6.00-16 tires
- 56 to 76 inches with 9.00-10 tires

## Ford 3000 and 4000 Narrow Orchard:

- 60 to 76 inches with 6.00-16 tires
- 61½ to 77½ inches with 7.50-16 tires
- 56 to 76 inches with 9.00-10 tires

## Ford 4000 SU

- 52 to 80 inches with 7.50-15 or 7.50-16 tires

## Ford 4000 and 5000:

- 52 to 80 inches with 6.00-16 tires
- 53½ to 81½ inches with 7.50-16 or 7.50-18 tires

## CHANGING FRONT WHEEL TREAD SETTINGS

### All Models Except Ford 4000 and 5000

1. Raise the front end of the tractor with a jack placed under the center of the front axle.
2. Working on one outer axle section at a time, remove the axle bolts, Figure 56.
3. Move the axle in or out until the desired setting is obtained, then reinstall the axle bolts through the holes according to the chart in Figure 56.

**NOTE:** To obtain the 80-inch tread width on Ford 2000, 3000, and 4000 SU Tractors, set the outer axle sections at the 72-inch position and reverse the wheels.

4. If necessary, remove the radius rod bolt and position the rod at hole "C" or "D" as specified in the chart. Reinstall the bolt.

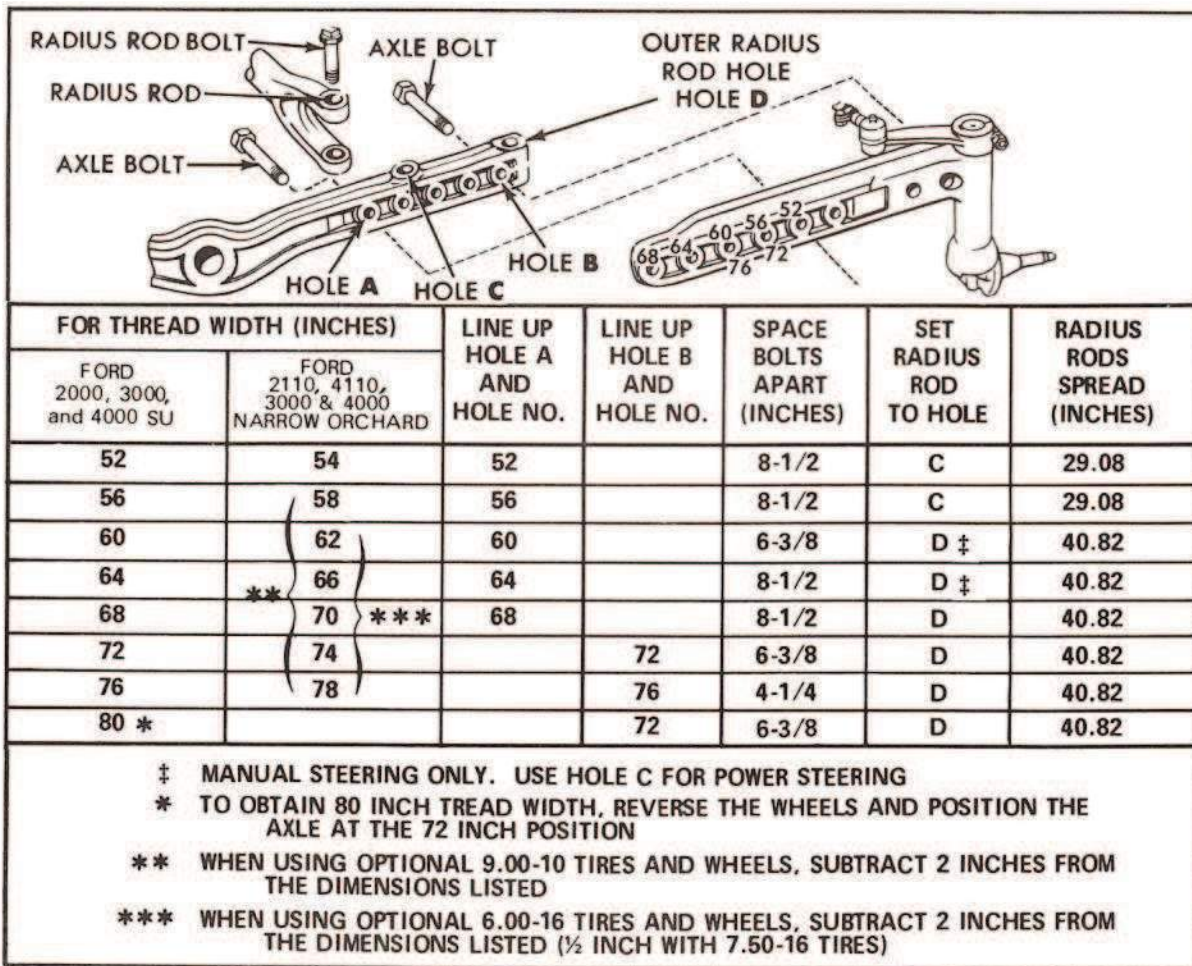
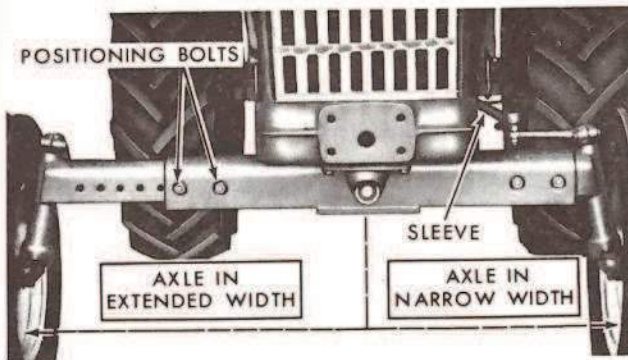


Figure 56  
 Front Wheel Tread Settings—Ford 2000, 2110, 3000,  
 4000 SU, and 4110

5. Tighten all nuts securely and remove the jack.
6. Check the toe-in as outlined on page 71.

#### Ford 4000 and 5000

1. Raise the front end of the tractor with a jack placed under the center of the front axle.
2. Working on one outer axle section at a time, remove the positioning bolts, Figure 57.



**Figure 57**  
Front Wheel Tread Settings—Ford 4000 and 5000

3. Remove the bolt from the spindle arm rod assembly (tie rod).
4. Move the axle in or out until the desired setting is obtained, then reinstall the positioning bolts.

**NOTE:** If the tread width of Ford 4000 Tractors is set at 52 inches or 56 inches, the drag link should be set to its shortest length. If the tread width is set from 60 to 76 inches, lengthen the drag link one notch for every 4-inch step beyond the 56-inch setting. To obtain the 80-inch tread width, set the axle to the 72-inch position and reverse the wheels. The drag link should be in the 72-inch position for the 80-inch tread width.

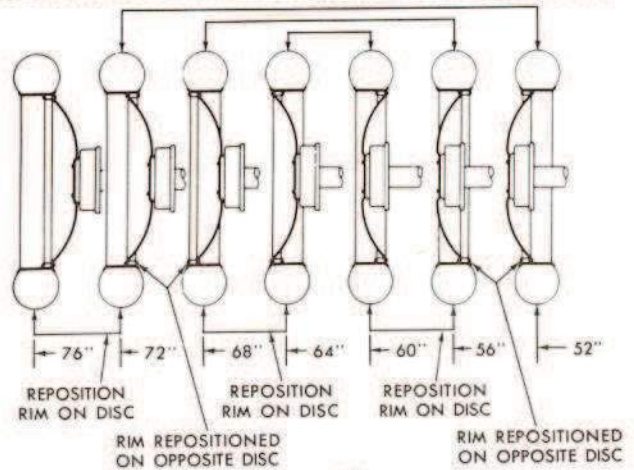
5. Position the front wheels in the straight-ahead position, then reinstall the bolt in the spindle arm rod assembly (tie rod).
6. Tighten all nuts securely and remove the jack.
7. Check the toe-in as outlined on page 71.

#### REAR WHEEL TREAD SETTINGS— MANUALLY ADJUSTED

**Ford 2000 and 3000:** The manually adjusted rear wheels are adjustable from 52 to 76 inches. Tread width settings are made by changing the position of the wheel discs and the rims to the positions shown in Figure 58.

**NOTE:** After changing the rear wheel tread settings, the wheel nuts should be torqued to 220-300 lbs. ft.

INTER-CHANGING REAR WHEEL ASSEMBLIES GIVE THESE COMBINATIONS



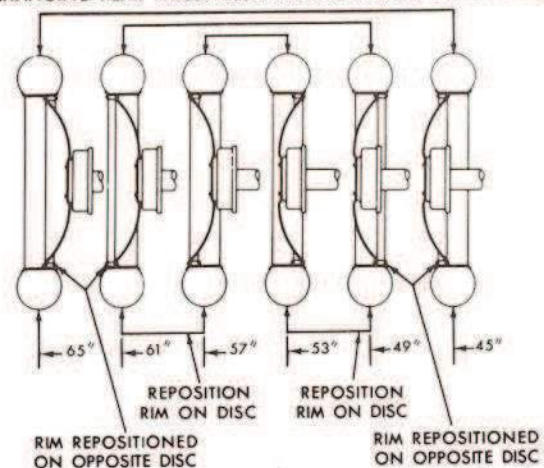
**Figure 58**  
Rear Wheel Tread Settings—Ford 2000 and 3000

**Ford 3000 and 4000 Narrow Orchard:** The manually adjusted rear wheels are adjustable from 45 to 65 inches. Tread width settings are made by changing the position of the wheel discs and rims to the positions shown in Figure 59.

**NOTE:** After changing the rear wheel tread settings, the wheel nuts should be torqued to 90-120 lbs. ft.

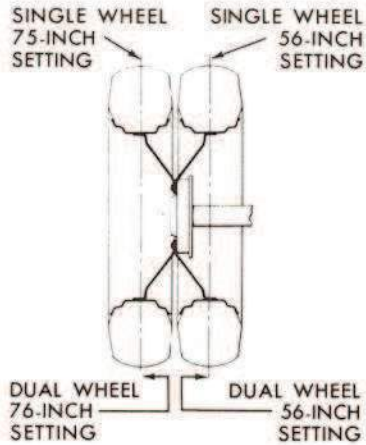
**Ford 2110 and 4110:** When equipped with the standard size 8.3-24 tires, the rear wheels can be set at either 56 or 75 inches. Tread width settings are made by reversing the position of the wheels on the axle as shown in Figure 60. When equipped with the optional 18.4-16A tires, the tread width is set at 75 inches and cannot be adjusted.

INTER-CHANGING REAR WHEEL ASSEMBLIES GIVE THESE COMBINATIONS



**Figure 59**  
Rear Wheel Tread Settings—Ford 3000 and 4000 Narrow Orchard

# OPERATION



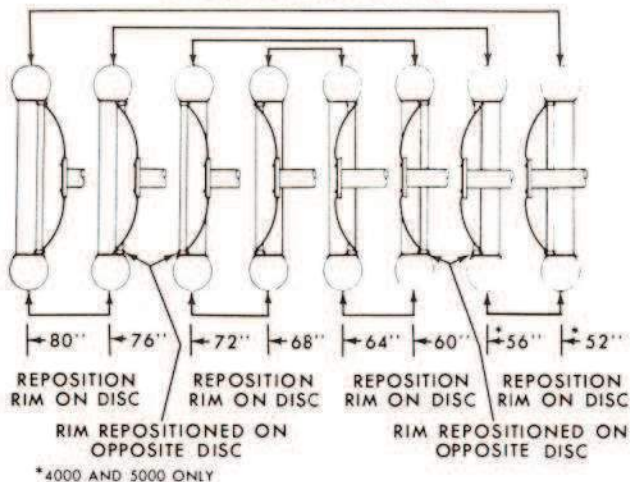
**Figure 60**  
Single and Dual Rear Wheel  
Tread Settings—Ford 2110 and 4110

**NOTE:** After changing the rear wheel tread settings, the disc-to-adaptor nuts should be torqued to 90-120 lbs. ft. and the adaptor-to-brake drum nuts should be torqued to 210-240 lbs. ft. The adaptor is not used with the optional 18.4-16A tires.

**Ford 4000, 4000 SU, and 5000:** The manually adjusted rear wheels on Ford 4000 and 5000 Tractors are adjustable from 52 to 80 inches. On the Ford 4000 SU, they are adjustable from 60 to 80 inches. Tread width settings are made by changing the position of the wheel discs and the rims to the positions shown in Figure 61.

**NOTE:** After changing the rear wheel tread settings, the wheel nuts should be torqued to 300-420 lbs. ft. Also, the wheels can be set at 56 inches on the Ford 4000 SU. However, at this

INTER-CHANGING REAR WHEEL ASSEMBLIES  
GIVE THESE COMBINATIONS



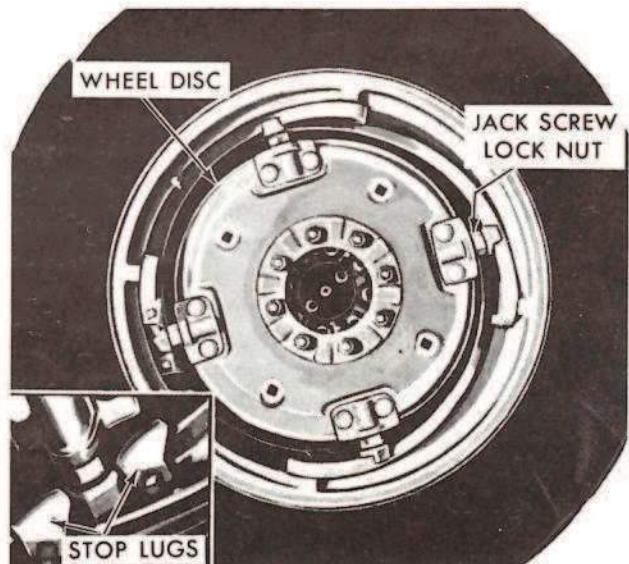
**Figure 61**  
Rear Wheel Tread Settings—Ford 4000, 4000 SU, and 5000

narrow setting the tractor tool box must be removed to prevent interference with the left lift arm with the fenders positioned in their narrowest position.

## REAR WHEEL TREAD SETTINGS— DUAL REAR WHEELS (OPTIONAL)

**Ford 2110 and 4110:** The dual rear wheels are set at 56 inches for the inner wheels, and at 76 inches for the outer wheels as shown in Figure 60. The tread width setting cannot be adjusted.

**Ford 4000 and 5000:** Tractors equipped with the optional power adjust rear wheels can be equipped with dual wheels by purchasing an extra set of tires, tubes, power adjust rims, and rim-to-disc attaching hardware from your Ford Tractor-Equipment Dealer. Both wheels are supported by the same disc. The inner wheels are set at 56 inches and the outer wheels at 90 inches. Although the dual wheels are on power adjust rims, they cannot be adjusted. If the outer wheels are removed, the inner wheels can then be power adjusted as covered on page 40. Before the outer wheels can be reinstalled, the inner wheels must be adjusted to 56 inches.



**Figure 62**  
Jackscrew Type Power Adjusted Rear Wheels  
(Special Order)—Ford 2000 and 3000

## REAR WHEEL TREAD SETTINGS— POWER ADJUSTED (OPTIONAL)

**Ford 2000 and 3000**

Two types of power adjusted rear wheels are available on Ford 2000 and 3000 Tractors. They are the jackscrew type, shown in Figure 62, and the clamp type, shown in Figure 63. Either type has two width ranges, depending

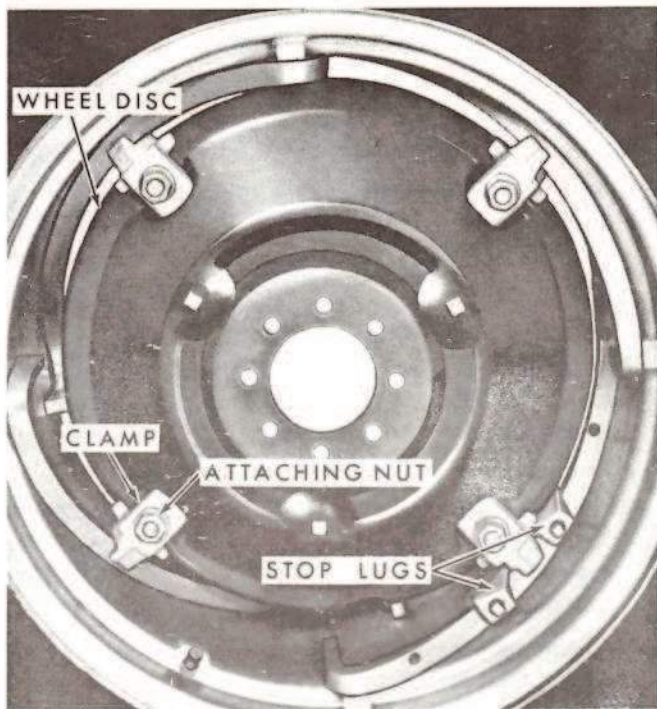


Figure 63  
Clamp Type Power Adjusted Rear Wheels—Ford 2000,  
3000, and 4000 SU (2000 and 3000 Shown)

upon the position of the wheel discs. The ranges are as follows:

**Jackscrew Type:** With the dished or hollow side of the discs "in", or toward the tractor as shown in Figure 62, the adjustment range is 52 to 72 inches with standard size tires.

With the dished or hollow side of the discs "out", or away from the tractor, the adjustment range is 60 to 80 inches with standard size tires.

**Clamp Type:** With the dished or hollow side of the discs "in", or toward the tractor as shown in Figure 63, the adjustment range is 52 to 64 inches with standard size tires.

With the dished or hollow side of the discs "out", or away from the tractor, the adjustment range is 60 to 80 inches with standard size tires.

#### Ford 4000 SU

The power adjusted rear wheels on the Ford 4000 SU Tractor are similar to the clamp type wheels used on the Ford 2000 and 3000 tractors except that they have one more clamp and rail. The adjustment range is as follows:

- 56 to 72 inches with the dished or hollow side of the discs "in", or toward the tractor as shown in Figure 63.
- 60 to 80 inches with the dished or hollow side of the discs "out" or away from the tractor.

#### Ford 4000 and 5000

The power adjusted rear wheels on the Ford 4000 and 5000 Tractors are shown in Figure 64. The wheels have two width ranges, depending on which side of the discs the clamps are on. The adjustment range is:

- 66 to 90 inches with the clamps on the outside of the discs as shown in Figure 64.
- 56 to 80 inches with the clamps on the inside of the discs.

#### Changing Tread Width Range

**Ford 2000, 3000, and 4000 SU:** To change the tread width range the wheels must be moved from one side of the tractor to the other. For example: If the dished or hollow side of the discs are "in", or toward the tractor as shown in Figures 62 and 63 (minimum range), remove the right wheel and install it on the left side so the dished or hollow side is "out", or away from the tractor (maximum range). The left wheel is then installed on the right side.

**NOTE:** After changing the tread width range, the wheel nuts should be torqued to 210-240 lbs. ft. (305 to 335 lbs. ft. on the Ford 4000 SU).

**Ford 4000 and 5000:** To change the tread width range, the clamps, Figure 64, must be moved from one side of the disc to the other as covered in this procedure.

**NOTE:** If the wheels are positioned fully inward with the clamps on the outside of the discs, or if the wheels are positioned fully

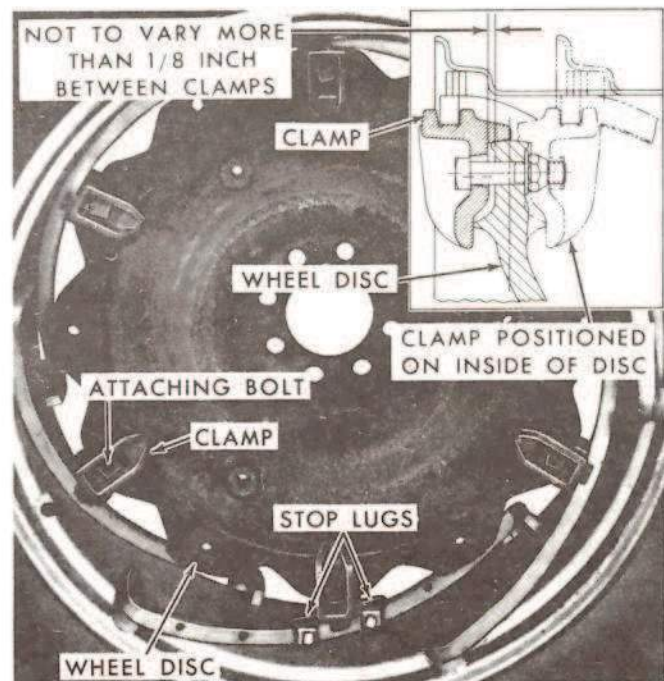


Figure 64  
Power Adjusted Rear Wheels (Optional)—  
Ford 4000 and 5000

## OPERATION

outward with the clamps on the inside of the discs, it will be necessary to move the stop lugs one position from the extreme and power adjust the wheels as covered in Steps 5 or 6 of the Ford 4000 and 5000 power adjust procedure before the clamps can be removed.

1. Position the tractor so the clamp that has the stop lugs beside it is at the bottom of the wheel, as shown in Figure 64, then loosen the nuts on all of the clamp attaching bolts.
2. Working at the top of the wheel on one clamp at a time, remove two or three clamps and install them on the opposite side of the disc so they will fit against the rail and disc. To obtain this "fit", it will be necessary to install the clamps one hole to the left or right of their former positions. Tighten the clamp attaching nuts only enough to hold the clamps in place on the disc. A high torque at this time will make it difficult to reposition the remaining clamps.
3. After moving the top two or three clamps, move the tractor forward or rearward so the clamp that has the stop lugs beside it is at the top of the wheel.
4. Remove the stop lugs and install the remaining clamps on the opposite side of the disc as in Step 2, then reinstall the stop lugs.
5. After all of the clamps are installed on the opposite side of the disc, tighten the clamp attaching nuts to 100 lbs. ft., then uniformly increase their tightness 50 lbs. ft. at a time until each has been torqued to 300-350 lbs. ft.
6. "Seat" the clamps with a hammer and protective block of wood, then retorque the attaching nuts to 300-350 lbs. ft.

**IMPORTANT:** Check the gap between the clamps and wheel disc. Insert, Figure 64. The gap should not vary more than  $\frac{1}{8}$  inch between all six clamps; otherwise the rim and tire will not turn true and a heavy side load may be placed on some of the rails.

### Power Adjust Procedure

#### Jackscrew Type—Ford 2000 and 3000:

1. Loosen all four jackscrew nuts, Figure 62, an equal number of turns.
2. Remove the stop lugs, Insert, Figure 62. Position one of the lugs at the desired setting on the rail and tighten it securely. Do not install the stop lug if the wheel is to be adjusted to its minimum or maximum setting. The rail itself will act as a stop. Each hole in the rail represents a 4-inch change in overall width (2 inches per wheel).
3. To move the left wheel out or in:

- Start the engine, depress the clutch or inching pedal and select a low forward gear ratio if the wheel is to be moved out (reverse gear if wheel is to be moved in).
  - Depress and hold the right brake pedal.
  - With the engine speed at idle, ease the clutch or inching pedal up, then immediately push it down when the jackscrew strikes the repositioned stop lug or the end of the rail.
4. To move the right wheel out or in:
    - Depress the clutch or inching pedal and select reverse gear ratio if the wheel is to be moved out (low forward gear if wheel is to be moved in).
    - Depress and hold the left brake pedal.
    - With the engine speed at idle, ease the clutch or inching pedal up, then immediately push it down when the jacksaw strikes the repositioned stop lug or the end of the rail.
  5. Reposition the other stop lug next to the jackscrew and tighten it securely.
  6. Tighten all of the jackscrew lock nuts to 100 lbs. ft., then uniformly increase their tightness 50 lbs. ft. at a time until each has been torqued to 200-250 lbs. ft.
  7. Check the exposed thread lengths of the jackscrews. The lengths must all be equal for the disc to be centered in the wheel.

#### Clamp Type:

1. **Ford 2000, 3000, and 4000 SU:** Loosen the nuts on all four or five clamp attaching bolts, Figure 63.
2. **Ford 2000, 3000, and 4000 SU:** Remove the stop lugs, Figure 63. Position one of the lugs at the desired setting on the rail and tighten its attaching screw to 25-40 lbs. ft. Do not install the stop lug if the wheel is to be adjusted to its maximum setting within the 52 to 64-inch range (56 to 72-inch for Ford 4000 SU), or to its minimum or maximum setting within the 60 to 80-inch range. The rail itself will act as a stop. Each hole in the rail represents a 4-inch change in overall width, 2 inches per wheel.

**IMPORTANT:** The rail cannot be used as a stop for the minimum setting of 52 inches on Ford 2000 and 3000 Tractors. Doing so will permit the wheel to move in too far, striking the fender. Install the stop lug in the next-to-last hole as shown in Figure 63. Also, on the Ford 4000 SU Tractor, the tool box must be removed if the fenders are in their narrowest position when the tread width is set at 56 inches, otherwise the left lift arm will interfere with the tool box.

3. **Ford 4000 and 5000:** Loosen the nuts on all the clamp attaching bolts, Figure 64.

4. **Ford 4000 and 5000:** Remove the stop lug, Figure 64, from the side of the clamp to which the wheel will be moved. Position the lug at the desired setting on the rail and tighten its attaching screw to 25-40 lbs. ft. Do not install the stop lug if the wheel is to be adjusted to its minimum or maximum setting within either the 56 to 80 or 66 to 90-inch range. The rail itself will act as a stop. Each hole in the rail represents a 4-inch change in over-all width, 2 inches per wheel.

**NOTE:** When adjusting the wheels to their minimum setting (56 inches), it may be necessary to move the fenders inward to provide clearance for the tires. This only applies to some of the larger optional size tires.

5. To move the left wheel out or in:

- Start the engine, depress the clutch or inching pedal and select a low forward gear ratio if the wheel is to be moved out (reverse gear if wheel is to be moved in).
- Depress and hold the right brake pedal.
- With the engine speed at idle, ease the clutch or inching pedal up, then immediately push it down when the clamp strikes the repositioned stop lug or the end of the rail.

6. To move the right wheel out or in:

- Depress the clutch or inching pedal and select reverse gear ratio if the wheel is to be moved out (low forward gear if wheel is to be moved in).
- Depress and hold the left brake pedal.
- With the engine speed at idle, ease the clutch or inching pedal up, then immediately push it down when the clamp strikes the repositioned stop lug or the end of the rail.

7. Reposition the other stop lug next to the clamp and tighten its attaching screw to 25-40 lbs. ft.

8. Tighten all of the clamp attaching nuts to 100 lbs. ft., then uniformly increase their tightness 50 lbs. ft. at a time until each has been torqued to:

- Ford 2000, 3000, and 4000 SU . . . . . 200-250 lbs. ft.
- Ford 4000 and 5000 . . . . . 300-350 lbs. ft.

9. "Seat" the clamps in opposite pairs with a hammer and protective block of wood, then retorque the attaching nuts to the torque specified above.

**IMPORTANT:** Check the gap between the support blocks and wheel disc, Insert, Figure 64. The gap should not vary more than 1/8 inch between all blocks, otherwise the rim and tire will not turn true and a heavy side load may be placed on some of the rails. This also applies to the Ford 2000, 3000, and 4000 SU wheels, Figure 63.

## TRACTOR WEIGHTING

To obtain sufficient traction for maximum performance in heavy draft operations and to counterbalance the tractor for heavy equipment operations, weight should be added to the tractor in the form of liquid ballast, cast iron weights, or a combination of both. Only enough weight should be added to provide good traction and stability.

Adding more weight than is needed results in unnecessary loads being imposed on the tractor and excessive fuel consumption.

**NOTE:** When adding weight, adhere to the tire load capacities. Refer to "TIRE PRESSURE" and the "TIRE INFLATION vs. PERMISSIBLE LOAD" chart on page 43.

## WEIGHTING LIMITATIONS

The weighting limitations that follow are limitations only, they do not imply that the tractor should be weighted to obtain the weights shown. Use only enough weight to get good performance, and do not exceed the tire load capacities. Do not add weight to the outer wheels of duals.

### Total Vehicle Weight

Total weight of the tractor, including liquid ballast, cast iron weights, and mounted equipment must not be greater than:

• Ford 2000 . . . . . 6000 lbs.	Ford 4000 . . . . . 8250 lbs.
• Ford 2110 . . . . . 5800 lbs.	Ford 4000 SU . . . . . 8250 lbs.
• Ford 3000 . . . . . 6900 lbs.	Ford 4110 . . . . . 5800 lbs.
	Ford 5000 . . . . . 9700 lbs.

### Total Rear Axle Weight

Total rear axle weight, including liquid ballast, cast iron weights, and mounted equipment must not exceed:

• Ford 2000 . . . . . 4150 lbs.	Ford 4000 . . . . . 6200 lbs.
• Ford 2110 . . . . . 4000 lbs.	Ford 4000 SU . . . . . 6200 lbs.
• Ford 3000 . . . . . 5000 lbs.	Ford 4110 . . . . . 4000 lbs.
	Ford 5000 . . . . . 7350 lbs.

Total rear axle weight is measured with only the rear wheels on the scales, with liquid ballast and/or cast iron weights in place, and with mounted equipment in the raised position.

### Straight Drawbar Limitations

If your tractor is used for straight drawbar work, ballast can be added to the front and rear in the amounts shown below, provided that the tire load capacities, as listed on page 43, and the preceding weighting limitations are adhered to.

## OPERATION

Tractor	Front Ballast*	Rear Ballast**
• Ford 2000	300 lbs. max.	2300 lbs. max.
• Ford 2110	300 lbs. max.	2300 lbs. max.
• Ford 3000	400 lbs. max.	3000 lbs. max.
• Ford 4000 SU	500 lbs. max.	3400 lbs. max.
• Ford 4000	500 lbs. max.	3400 lbs. max.
• Ford 4110	300 lbs. max.	2300 lbs. max.
• Ford 5000	730 lbs. max.	4000 lbs. max.

\*Includes both liquid and cast iron wheel weights, as well as cast iron front end weights.

\*\*Includes both liquid and cast iron wheel weights.

### LIQUID BALLAST

It is common practice to weight the tractor by filling the front and rear tires with liquid. A calcium chloride-water solution is recommended because of its low freezing point and greater weight per gallon than water. Because special equipment is required to fill the tires, we recommend that you see your Ford Tractor-Equipment Dealer.

The following table lists the tire sizes available, along with weighting information for each. The table is based on 75% fill and the fact that 5 pounds calcium chloride added to one U.S. Gallon (0.83 Imp. Gal.) of water equals 13.35 pounds total weight.



**CAUTION:** *Never pour water on calcium chloride. Slowly add the flakes to the water and stir until dissolved.*

In some instances it will be necessary to reduce the amount of water and calcium chloride per tire to stay within the weighting limitations. For example: If it is determined that 475 lbs. of liquid ballast can be added to each rear tire without "going overweight", divide 13.35 into 475 to compute the "Water Per Tire" requirement. Then, multiply that figure by 5 to compute the "Calcium Chloride Per Tire" requirement.

#### Example:

- 13.35 lbs. divided into 475 lbs. equals \*35.6. This is the number of U.S. Gallons of Water Required Per Tire, each weighing 8.35 lbs. (\*Multiply 35.6 by 0.83 to find Imperial Gallons)
- 5 lbs. times 35.6 equals 178.0 lbs. Calcium Chloride Per Tire.
- 178.0 lbs. calcium chloride added to 35.6 U.S. Gallons (30.5 Imp. Gals.) of water, each weighing 8.35 lbs., equals 475 lbs. total weight.

### RECOMMENDED LIQUID WEIGHT 75% FILL

Tire Size	Pounds Calcium Chloride Per Tire	Gallons of Water Per Tire		Pounds Weight of Solution Per Tire
		U.S.	Imp.	
5.50-16	18	3.5	2.9	47
6.00-16	24	4.8	4.0	64
6.50-13	7.2	1.6	1.3	19.2
7.50-15	32.5	6.5	5.4	87
7.50-16	37	7.3	6.1	98
7.50-18	40	8	6.7	107
8.3-24	50	10	8.3	133
9.00-10	36	7.2	6.0	96
11.2-28	110	22	18.3	293
12.4-28	140	28	23.3	374
12.4-38	185	37	30.8	494
13.6-24	155	31	25.8	414
13.6-28	175	35	29.2	467
13.6-38	230	46	38.3	614
14.9-24	190	38	31.7	507
14.9-28	215	43	35.8	574
14.9-30	230	46	38.3	614
15.5-38	265	53	44.1	707
16.9-24	245	49	40.8	654
16.9-26	260	52	43.3	694
16.9-30	295	59	49.1	787
18.4-16A	165	33	27.5	438
18.4-26	320	64	53.3	854
18.4-30	360	72	60.0	960

The above figures are for individual tires only. For combined front axle and/or rear axle weight, multiply the figures by 2.

### CAST IRON WEIGHTS

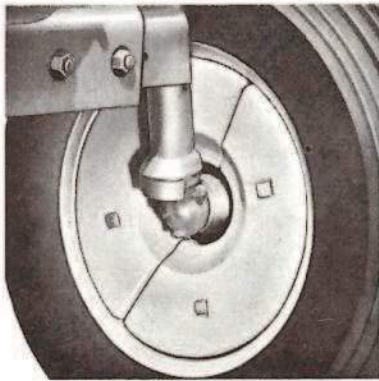
Cast iron weights are available as accessories from your Ford Tractor-Equipment Dealer. Weights can be mounted on the front wheels, on the front end of the tractor, and on the rear wheels as shown in Figures 65 through 67. Do not add weight to the outer wheels of duals.

Vari-Weights, if available, can also be used on the 24- or 28-inch rear wheels. When the vari-weights are used on the 24-inch wheels, a set of rear wheel flange nuts must be used to extend the weight disc away from the wheel rim.

**NOTE:** *On 14.9-24 optional tires, the rear wheel weights must be installed with three brackets and the bracket attaching bolts must be tightened after operating 5 hours.*

If additional information is required when adding weight to your tractor, see your Ford Tractor-Equipment Dealer.

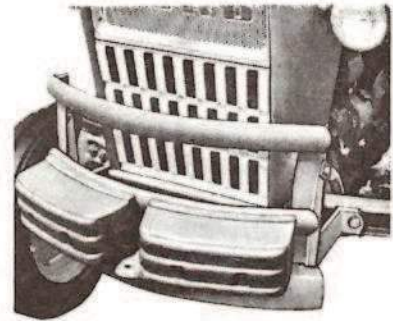




**Figure 65**  
Front Wheel Weights—Ford 2000,  
3000, 4000, and 5000



**Figure 66**  
Rear Wheel Weights—Ford 2000,  
3000, 4000, 4000 SU and 5000



**Figure 67**  
Bumper Weights—Ford 2000,  
3000, and 4000 SU

### TIRE PRESSURE

Tire pressure must be considered when adding weight to the tractor. The following "TIRE INFLATION vs. PERMISSIBLE LOAD" table lists the tire sizes available and shows the maximum load they can carry for a given air pressure. Note that the load capacities decrease as inflation pressures decrease, and also that a specific tire pressure is recommended for certain size tires.

### TIRE INFLATION VS. PERMISSIBLE LOAD

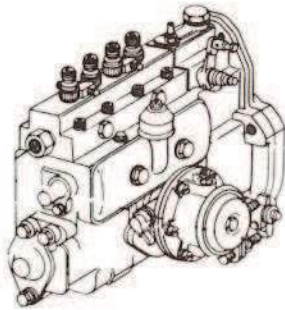
Front Tire Size	INFLATION PRESSURES (psi)						Rear Tire Size	INFLATION PRESSURES (psi)						
	12	16	20	24	28	32		36	12	14	16	18	20	22
	MAXIMUM PERMISSIBLE LOAD (Lbs.)							MAXIMUM PERMISSIBLE LOAD (Lbs.)						
5.50-16 4 ply	---	---	655	725	795	860	---	8.3-24 4 ply	---	1055	1140	1220	1300	1370
6.60-16 4 ply	---	---	750	835	915	990	---	11.2-28 4 ply	1575	1720	1860	---	---	---
6.50-13 4 ply	---	---	730	810	885	---	---	12.4-28 4 ply	1890	2070	---	---	---	---
7.50-15 6 ply	---	---	1045	1160	1265	1370	1470	12.4-38 4 ply	2185	2390	---	---	---	---
7.50-16 4 ply	---	---	1110	1235	---	---	---	13.6-24 4 ply	---	2270	---	---	---	---
7.50-16 6 ply	---	---	1110	1235	1345	1455	1560	13.6-28 4 ply	---	2430	---	---	---	---
7.50-18 4 ply	---	---	1205	1340	---	---	---	13.6-38 4 ply	---	2810	---	---	---	---
9.00-10 4 ply	800	1280	---	---	---	---	---	14.9-24 4 ply	---	2700	---	---	---	---
								14.9-28 4 ply	---	2880	---	---	---	---
								14.9-30 6 ply	---	2960	3200	3430	---	---
								15.5-38 6 ply	---	3160	3420	3660	---	---
								16.9-24 6 ply	---	---	3560	---	---	---
								16.9-26 6 ply	---	---	3680	---	---	---
								16.9-30 6 ply	---	---	3920	---	---	---
								*18.4-16A 6 ply	---	2660	2880	---	---	---
								18.4-26 6 ply	---	---	4370	---	---	---
								18.4-30 6 ply	---	---	4650	---	---	---

**NOTE:** Do not exceed the maximum load listed. Do not under-inflate or over-inflate the tires.

\*18.4-16A 6 ply tires can be used at 10 psi, providing maximum load does not exceed 2180 lbs. per tire.

\*18.4-16A 6 ply  
18.4-26 6 ply  
18.4-30 6 ply

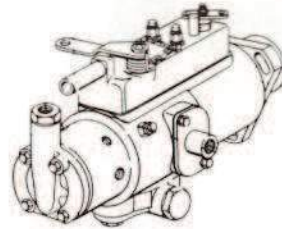
The above figures are for individual tires only. For maximum permissible loads that can be carried by both front tires or both rear tires, multiply the figures by 2.



IN-LINE PUMP



INJECTOR



DISTRIBUTOR PUMP

## Diesel Injection Service

Don't lose diesel power and economy because of dirty or improperly adjusted injectors. Prompt and expert attention can correct excessive pressure buildup which can lead to wasteful fuel consumption, hard starting, loss of power, and possible pump damage.

Let your Ford Tractor-Equipment Dealer give your diesel a complete check-up. He offers a diesel pump and injector exchange service which features:

- **LOW COST** – substantially less than new.
- **FAST SERVICE**
- **WARRANTY** – same as for new pump and injectors.
- **PRECISION WORKMANSHIP** – by Ford diesel specialists for like-new performance.

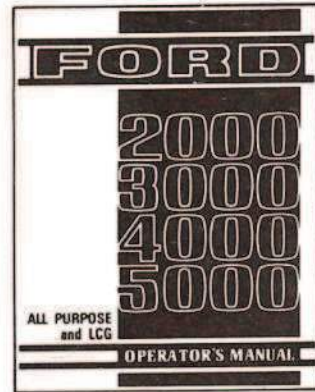
**YOU'LL FIND  
ALL THIS ONLY  
WHERE YOU  
SEE THIS SIGN**



# lubrication

# and

# maintenance



This section deals with fuels and lubricants. Fuel-and-lubricant-storage and detailed service procedures are included, along with the recommended hourly service intervals listed in the lubrication and maintenance charts. Adjustment and general maintenance procedures are also included. Regular attention at the specified interval will pay dividends in maximum efficiency and longer life.

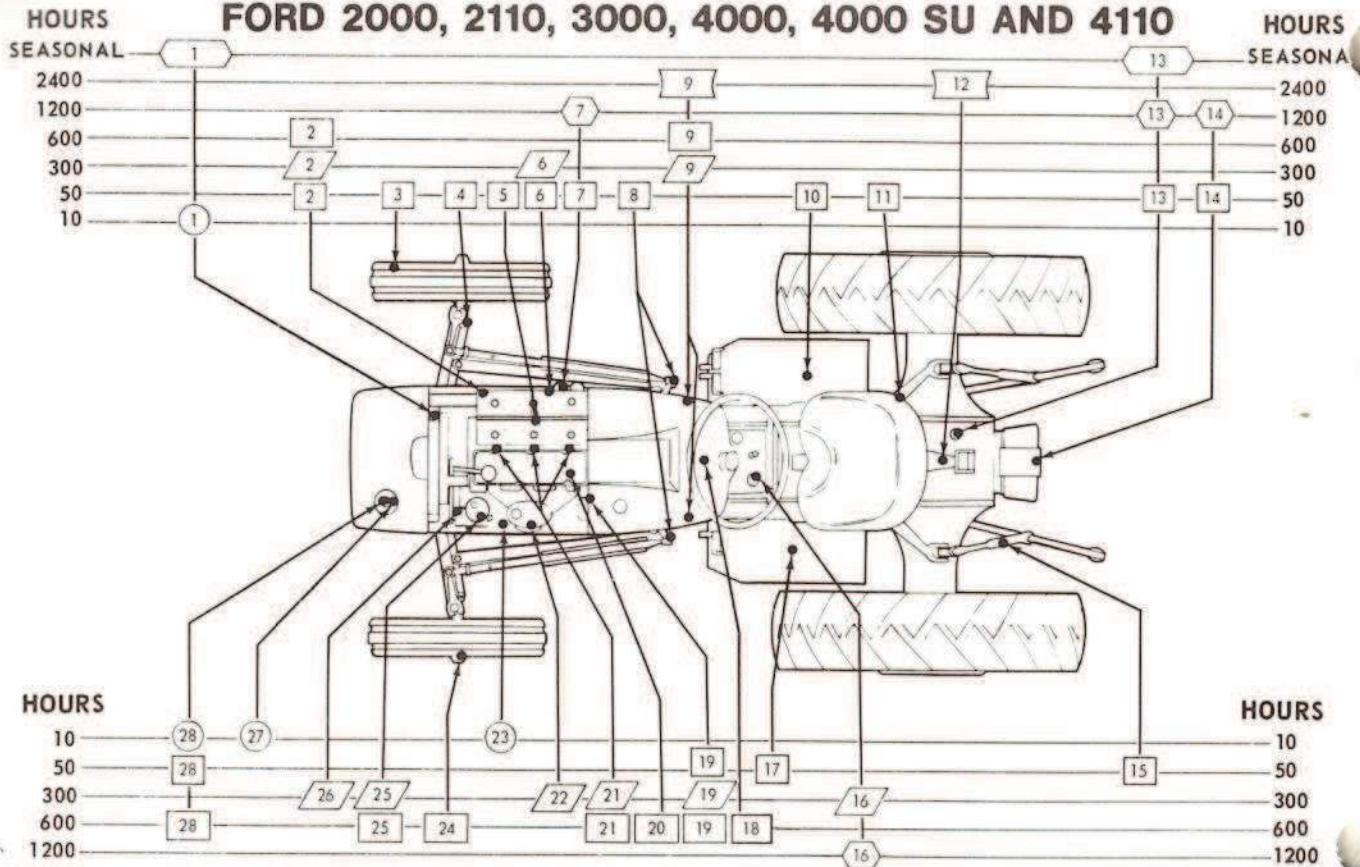
Oil levels should be checked every 10 hours during the first 50 hours of operation. After the first 50 hours of operation, oil levels should be checked at the recommended hourly intervals. For the first 50 hours, check:

- Engine oil level. See page 50.
- Power steering oil level. See page 59.
- Transmission oil level. See page 55.
- Tractor hydraulic system oil level (rear axle). See page 57.
- To prevent oil contamination when checking or changing lubricants and filters, always clean the area surrounding the level plugs, filler plugs, dipsticks, and filters.



**Properly maintained Equipment  
is Safe Equipment.**

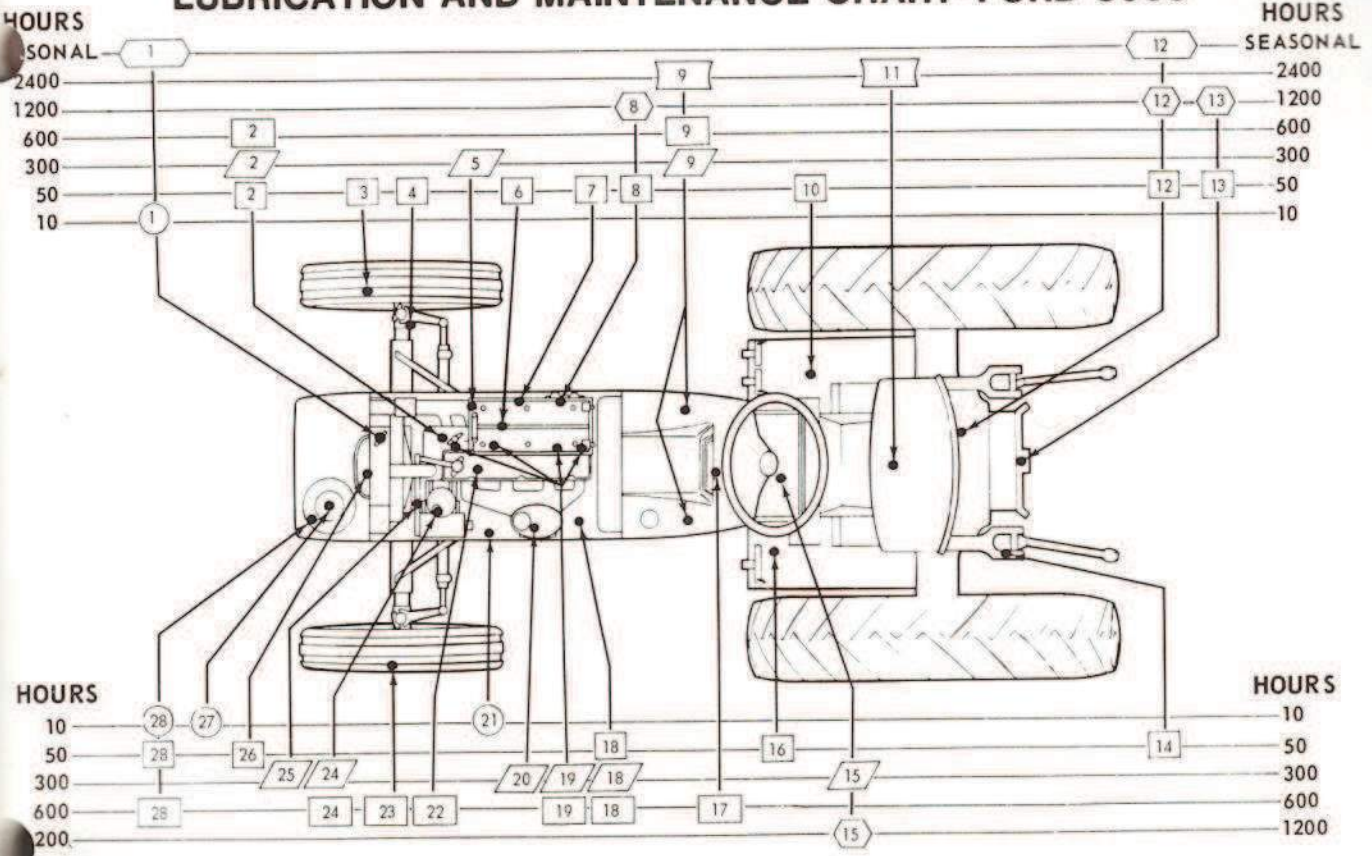
# LUBRICATION AND MAINTENANCE CHART- FORD 2000, 2110, 3000, 4000, 4000 SU AND 4110



## KEY TO LUBRICATION AND MAINTENANCE CHART

SERVICE INTERVAL	NO.	LUBRICATION AND MAINTENANCE ITEMS	CHECK	CLEAN	LUBE	CHANGE	ADJUST	PAGE NO.	SERVICE INTERVAL	NO.	LUBRICATION AND MAINTENANCE ITEMS	CHECK	CLEAN	LUBE	CHANGE	ADJUST	PAGE NO.	
Every 10 Hours or Daily	28	Air Cleaner (Oil Bath)	•					54	Every 300 Hours	-	Breaker Points	•					67	
	27	Pre-Cleaner Bowl (Acc)		•				54		21	Spark Plugs		•			•		68
	23	Engine Oil Level	•					50		26	Fan Belt	•				•		62
	1	Radiator (Cooling System)	•					61		6	In-Line Breather		•					52
Every 50 Hours	19	Air Cleaner (Dry Type)		•				54	25	Power Steering Reservoir	•						59	
	28	Air Cleaner (Oil Bath)	•	•		•		54	9	Select-O-Speed Trans. Oil Level	•						55	
	6	Sediment Bowl						53	16	Manual Shift Trans. Oil Level	•						57	
	7	Fuel Filter				DRAIN		52										
	5	Battery	•					69	19	Air Cleaner (Dry Type)		•			•		55	
	2	Distributor			•			51	28	Air Cleaner (Oil Bath)			•				54	
	-	Lubrication Fittings:							21	Fuel Injectors	•				•		64	
	4	Front Wheel Spindles			•			61	2	Distributor Points					•		67	
	10	Brake Pedal Pivots			•			61	21	Spark Plugs					•		68	
	17	Clutch Pedal Pivots			•			61	20	Valve Clearance					•		68	
	8	Power Steering Cylinders			•			61	18	Steering Housing Oil Level	•						59	
	11	Diff. Lock Pedal Pivots			•			61	25	Power Steering Oil & Filter					•		60	
	15	Hydraulic Lift Linkage			•			61	9	Select-O-Speed Bands					•		57	
13	Rear Axle Oil Level	•					57	24	Front Wheel Bearings				•			70		
14	Belt Pulley Oil Level	•					60											
3	Tires	•					70	7	Fuel Filter					•		52		
17	Clutch Pedal	•					72	13	Rear Axle Oil					•		58		
Every 300 Hours	22	Engine Oil and Oil Filter				•		51	16	Manual Shift Trans. Oil				•			57	
	19	Air Cleaner (Dry Type)		•				55	14	Belt Pulley Oil				•			61	
	2	Distributor:						51	12	Hydraulic Filters					•		58	
	-	Cam						51	9	Select-O-Speed Trans. Oil					•		56	
	-	Cam Center Spindle			•			51	-	Filter					•		56	
	-	Gov. Weight Mechanism			•			51	Seasonal	1	Radiator Coolant					•		61
									13	Rear Axle Oil							Refer to Page 58	

# LUBRICATION AND MAINTENANCE CHART-FORD 5000



## KEY TO LUBRICATION AND MAINTENANCE CHART

SERVICE INTERVAL	NO.	LUBRICATION AND MAINTENANCE ITEMS	CHECK	CLEAN	LUBE	CHANGE	ADJUST	PAGE NO.	SERVICE INTERVAL	NO.	LUBRICATION AND MAINTENANCE ITEMS	CHECK	CLEAN	LUBE	CHANGE	ADJUST	PAGE NO.	
Every 10 Hours or Daily	28	Air Cleaner (Oil Bath)	•					54	Every 300 Hours	-	Breaker Points	•				•	67	
	27	Pre-Cleaner Bowl (Acc)		•				54		19	Spark Plugs		•				•	68
	21	Engine Oil Level	•					50		25	Fan Belt	•					•	62
	1	Radiator (Cooling System)	•					61		5	In-Line Breather		•					
Every 50 Hours	18	Air Cleaner (Dry Type)		•				54	Every 600 Hours	9	Select-O-Speed Trans. Oil Level	•						55
	28	Air Cleaner (Oil Bath)		•		•		54		15	Manual Shift Trans. Oil Level	•						57
	7	Sediment Bowl		•				53		Every 1200 Hours	18	Air Cleaner (Dry Type)				•		55
	8	Fuel Filters				DRAIN		52			28	Air Cleaner (Oil Bath)		•				•
	6	Battery	•					69	19		Fuel Injectors	•					•	64
	2	Distributor			•			51	2		Distributor Points					•		67
	-	Lubrication Fittings:							19		Spark Plugs					•		68
	4	Front Wheel Spindles			•			61	22		Valve Clearance	•					•	68
	10	Brake Pedal Pivots			•			61	17		Steering Housing Oil Level	•						59
	16	Clutch Pedal Pivot			•			61	24		Power Steering Oil & Filter					•		60
	26	Steering-Center Arm			•			61	9		Select-O-Speed Bands						•	56
	14	Hydraulic Lift Linkage			•			61	3		Front Wheel Bearings				•			70
	12	Rear Axle Oil Level	•					57	Every 2400 Hours	8	Fuel Filters				•		52	
	13	Belt Pulley Oil Level	•					60		12	Rear Axle Oil				•		•	58
3	Tires	•					70	15		Manual Shift Trans. Oil				•		•	57	
16	Clutch Pedal	•				•	72	13		Belt Pulley Oil				•		•	61	
Every 300 Hours	20	Engine Oil and Filter				•		51	Every 2400 Hours	11	Hydraulic Filters				•		58	
	18	Air Cleaner (Dry Type)		•				55		9	Select-O-Speed Trans. Oil				•		•	56
	2	Distributor:						51		-	Filter			•			•	56
	-	Cam			•			51	Seasonal	1	Radiator Coolant					•		61
	-	Cam Center Spindle			•			51		12	Rear Axle Oil							
-	Gov. Weight Mechanism			•			51											

# LUBRICATION AND MAINTENANCE

## FUELS AND LUBRICANTS

### DIESEL FUEL

#### Type of Fuel to Use

When operating in temperature above 20°F, use diesel fuel oil No. 2 (No. 2D) with a minimum cetane rating of 45. When operating in temperatures below 20°F, use diesel fuel oil No. 1 (No. 1D) with a minimum cetane rating of 50.

Fuel represents a major portion of your tractor operating costs; therefore, it is important to use it efficiently. Do not let cost tempt you to use inferior diesel fuel. The initial savings is a false economy when you consider the damage poor fuel can do to your tractor engine.

**NOTE:** Use only diesel fuel designated for diesel engines. Some heating fuels contain harmful chemicals that can seriously affect tractor efficiency and performance. Refer to the "Engine Oil Recommendations" on page 50 for additional diesel fuel information.

#### Storage

Extremely small clearances exist between the fuel delivering elements of the fuel injection pump and the fuel delivering elements of the injectors. Therefore, it is of vital importance that precautions be taken to make sure the fuel is kept free of dirt and water. See Figure 68.

Diesel fuel should be stored in black iron tanks or containers. Do not store diesel fuel in a galvanized tank, as the zinc coating will react with the fuel and form undesirable compounds that may interfere with the proper operation of the fuel injection pump and injectors.

The most satisfactory arrangement is a bulk storage installation with either a tank and pump, Figure 69, or a gravity feed installation located high enough for the tractor tank to be filled direct. The tank should slope downward at the rear to allow sediment to settle away from the take-off point. Whenever the tank is refilled, allow the fuel to settle for 12 hours before using. A drain valve should be positioned at the lowest point in the tank so the moisture and sediment can be drained periodically. A fuel outlet filter should be used, as shown in Figure 69. Use the largest tank feasible and keep it as full as possible to minimize condensation.

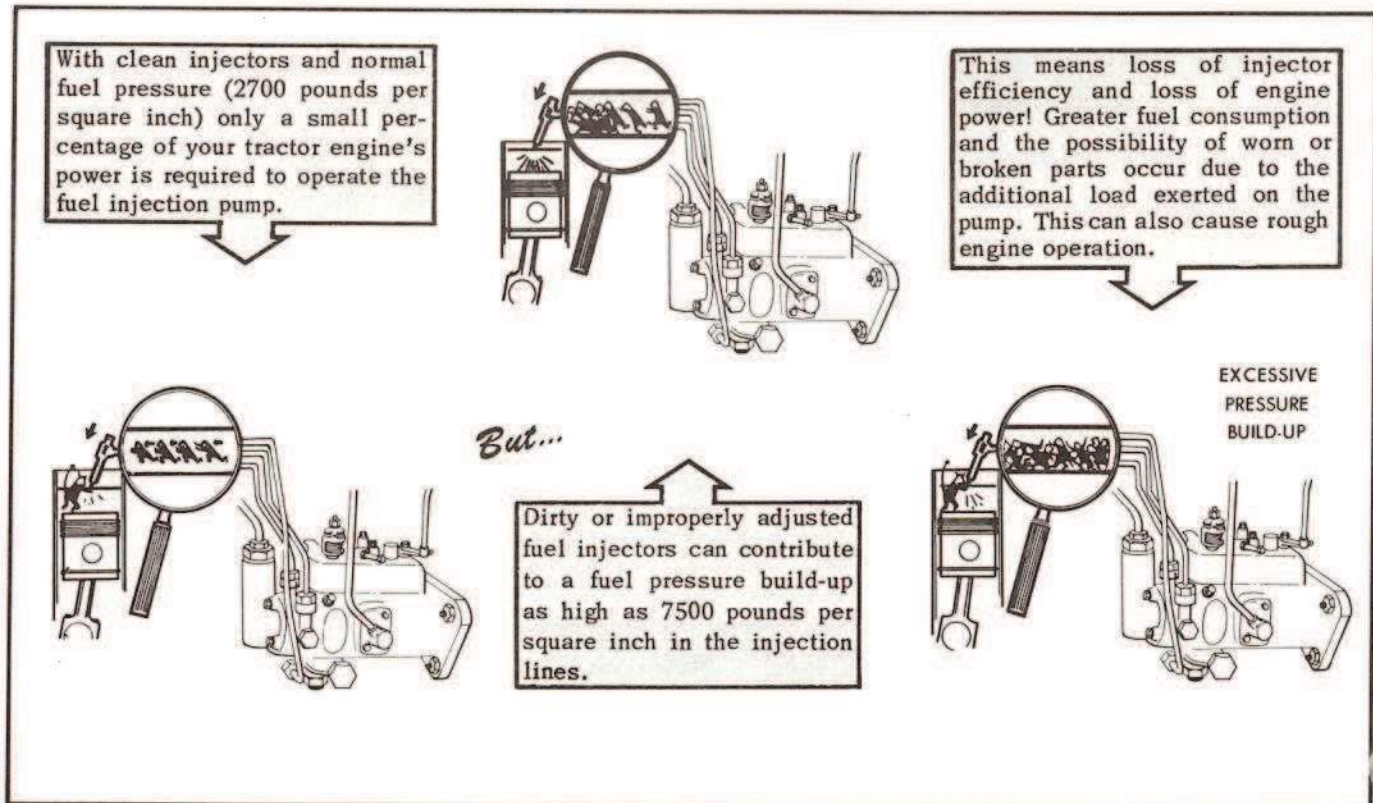


Figure 68  
Dirt vs. Injectors

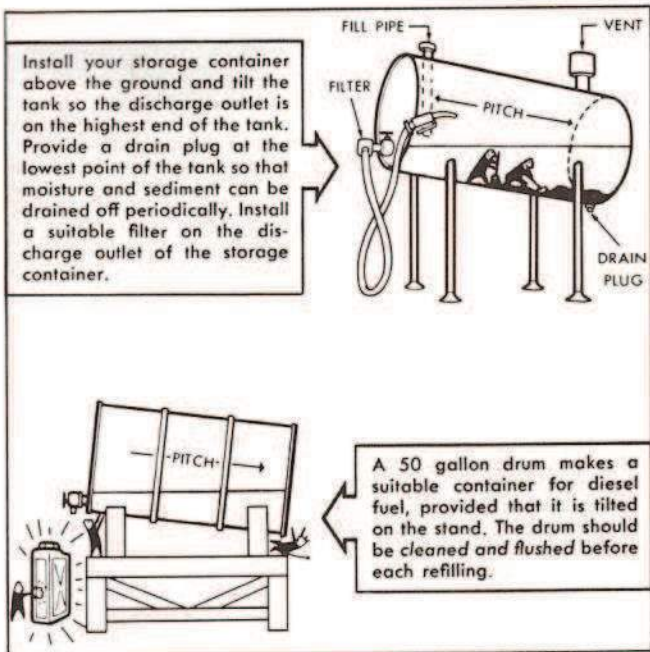


Figure 69  
Diesel Fuel Storage

If bulk storage is not possible and the fuel is stored in barrels, keep them in a clean, dry place. The barrel in use should be fitted with a fuel outlet filter and a drain tap, and should be supported so it slopes downward 1/2 inch per foot length away from the tap. Never tip the barrel to use fuel below the level of the tap.

After use, install the cap at the top of the barrel and clean up fuel which may have been spilled. Diesel fuel will not evaporate and will collect dust and dirt.

## GASOLINE FUEL

### Type of Fuel to Use

Ford gasoline engines are designed to operate most efficiently with good quality **regular grade** gasoline. The use of poor quality fuel can cause knocking, overheating, and ultimately, engine failure.

For summer operation, use summer grade fuel. For winter operation, use winter grade fuel.

Use of highly volatile winter grade fuel during warm weather can result in vapor lock or sluggish engine performance. Use of summer grade fuel in cold weather can result in hard starting. Consult your fuel dealer.

### Storage

Local regulations on fuel storage vary, but a tank similar to that recommended for diesel fuel should be used, regulations permitting. The tank should be properly vented, marked as to contents, and located in a cool, dry place to reduce evaporation losses, Figure 70. By limiting the quantity of fuel stored to about a 30-day supply, the following advantages are gained:

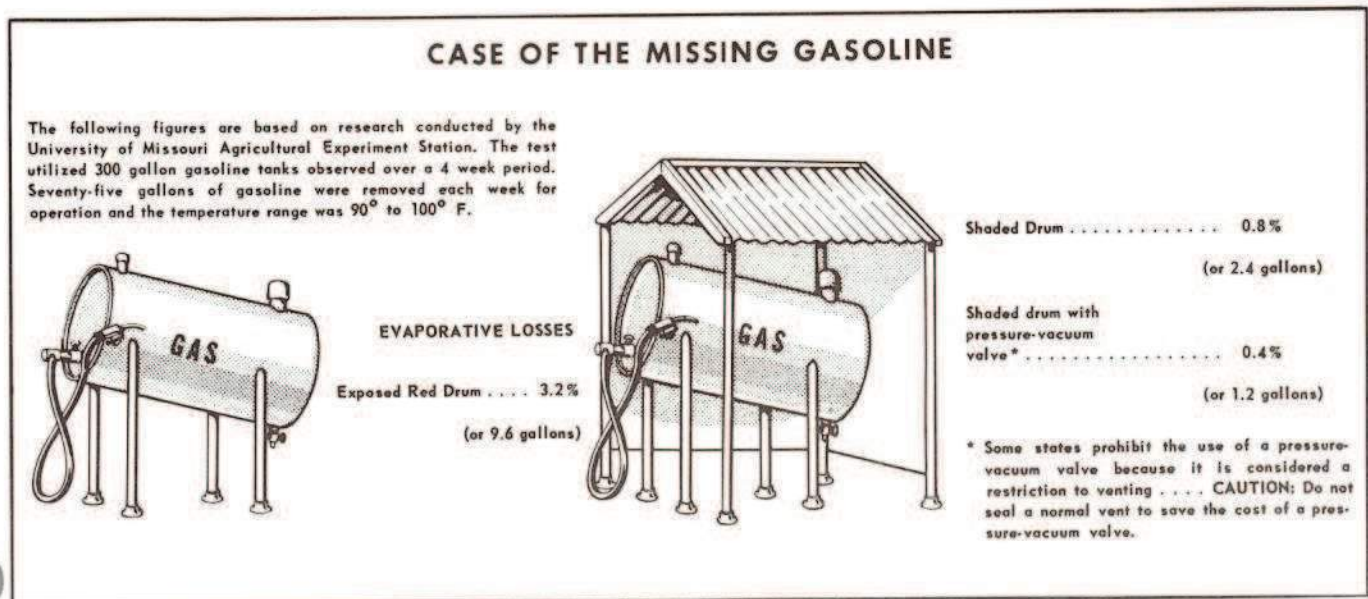


Figure 70  
Gasoline Storage

# LUBRICATION AND MAINTENANCE

- For easier starting, oil companies blend their fuel so volatility is adjusted to the outside temperatures. A 30-day supply will reduce winter hard starting due to a storage of summer grade fuel. It will also reduce the possibility of summer vapor lock or sluggish engine problems from the use of winter grade fuel.
- A short storage period will lessen fuel evaporation and subsequent gum formation.

## REFUELING THE TRACTOR

If there is no filter on the outlet of the storage tank, filter the fuel through a 100-mesh screen or finer when filling the tractor fuel tank. Keep the tractor tank as full as possible to minimize condensation.

**NOTE:** It is a good practice to fill the tractor fuel tank with fuel at the end of each day, as this will reduce overnight condensation. Also, any fuel which may have been spilled should be cleaned up.

## LUBRICANTS

### Type of Lubricant to Use

Engine Oil ..... Ford M-2C121-A  
 (SAE 30 for Summer use—above 32° F)  
 (SAE 10W for Winter use—below 32° F)

**NOTE:** Ford Tractor 300 Engine Oil, a super premium, heavy duty low ash engine oil compounded specifically to meet the rigid requirements of Ford tractor engines, is available from your Ford Tractor-Equipment Dealer. Should you prefer to use an equivalent commercial oil, refer to the following chart:

Temperature	Viscosity Grade & API Classification	
	Diesel	Gasoline
Below + 10° F	SAE 5W (DM)	SAE 5W (MS) or SAE 5W-20 (MS)
+ 10° F to 40° F	SAE 10W (DS)	SAE 10W (MS) or SAE 5W-20 (MS)
32° F to 90° F	SAE 20 (DS)	SAE 20 (MS) or SAE 10W-30 (MS)
Above 75° F	SAE 30 (DS)	SAE 30 (MS) or SAE 10W-30 (MS)

**NOTE:** When using diesel fuel with a sulfur content below 1.0%, diesel engine oil with an API Classification of DM may be used instead of a DS oil, but the oil and filter change interval must be reduced to 150 hours. When the sulfur content of a fuel is greater than 1.0%, but less than 1.3%, a DS oil must be used (except for temperatures of 10° F and below), and the oil and filter change interval must be reduced to 150 hours. The use of fuel with a sulfur content above 1.3% is not recommended.

Manual Shift Transmission Oil ..... Ford M-2C53-A  
 Select-O-Speed Transmission Oil ..... Ford M-2C41-A  
 Hydraulic System (Rear Axle) Oil ..... Ford M-2C53-A  
 Belt Pulley Oil ..... Ford M-2C53-A  
 Steering Gear Housing (Manual and Power) Oil ..... Ford M-2C53-A  
 Power Steering Reservoir Oil ..... Ford M-2C41-A  
 Front Wheel Bearings and All Lubrication Fittings ..... good quality, multi-purpose, lithium base, cup-type grease

### Storage

Your new Ford Tractor is equipped with suitable lubricant filters to protect vital points from damage by dirt which may enter under normal operating conditions. Precautions must, however, be taken by you to prevent lubricant contamination by dirt or water during storage. Service intervals in this section are based on the assumption that only new oil, of the type specified, is used.

Barrels of lubricant should be kept under cover, preferably in a clean, dry place, and they should be clearly marked to indicate the lubricant which they contain.

When a barrel is kept in an exposed location it should be tilted to allow any moisture to run away from the filler cap. Always use a clean container when transferring oil from a barrel to the tractor and make sure that any cap or bung, which has been removed, is installed as soon as possible.

## FUEL AND LUBRICANT SERVICE PROCEDURES

### ENGINE

**Checking Oil Level:** Check the engine oil level daily or every 10 hours.

1. With the tractor standing level, and after the engine has been stopped for a period of time, check the engine oil level with the dipstick, Figure 71.





**Figure 71**  
Engine Oil Level Dipstick

2. If the oil level is low, remove the filler cap, Figure 72, and add oil to the engine through the filler hole in the rocker cover to bring the oil level to the "FULL" mark on the dipstick. Be careful not to overfill.
3. Install the oil filler cap.

**Changing Oil and Filter:** Change the engine oil and filter every 300 hours.

1. With the engine off, but at normal operating temperature, drain and discard the engine oil by removing the drain plug, Figure 73. Reinstall the plug after the oil has drained.
2. Unscrew the oil filter, Figure 74, catching the used oil in a suitable container placed below the filter. Discard the filter.
3. Coat the gasket on the filter with a film of oil. Screw the filter into place until the gasket contacts its mating surface, then turn the filter approximately  $\frac{3}{4}$  of a turn by hand. Do not over-tighten.
4. Add new oil of the type specified, page 50. Start the engine and check the filter for leaks after adding the oil.



**Figure 72**  
Engine Oil Filler Cap



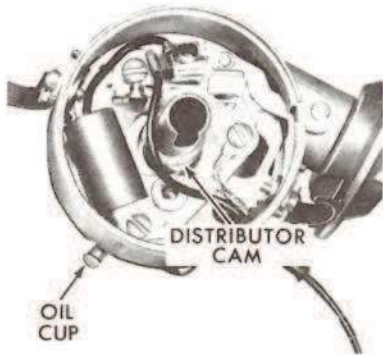
**Figure 73**  
Engine Oil Pan Drain Plug

**Lubricating Distributor (Gasoline):** Oil the distributor through the oil cup, Figure 75, with seasonal oil every 50 hours. Grease the cam every 300 hours as follows:

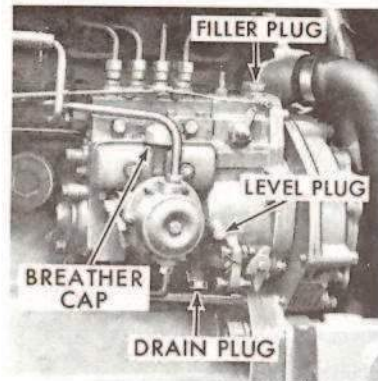
1. Release the spring clips and remove the cap, rotor, and dust cover.
2. Apply a small amount of distributor cam grease or ball bearing grease on the distributor cam, Figure 75. Do not use oil on the cam and do not over-lubricate.
3. Add two drops of engine oil to the cam center spindle and lubricate the distributor weight mechanism by adding a few drops of oil through the contact breaker base plate.
4. Lubricate the distributor shaft bushing by adding oil to the oil cup.
5. Clean the primary wire terminal and surrounding area. Make sure the distributor cap is clean inside and outside and that cracks do not exist.
6. Check the condition of the points and install new points if they are burned or pitted. Refer to "Distributor Points,"



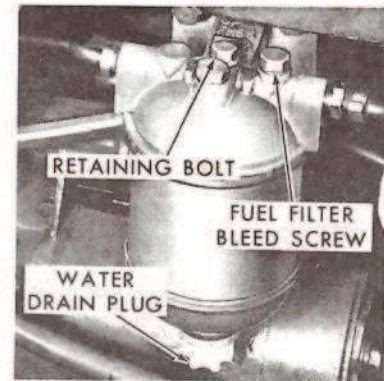
# LUBRICATION AND MAINTENANCE



**Figure 75**  
Distributor Lubrication Points



**Figure 76**  
Fuel Injection Pump—  
Ford 3000 and 5000



**Figure 77**  
Fuel Filter Bleed Screw and Drain  
Plug—In-Line Pump (Ford 3000)

page 67, for point removal and installation procedures. If the points are dirty, clean them and check the gap as outlined in the procedure.

## IN-LINE FUEL INJECTION PUMP (DIESEL)

The in-line fuel injection pump on Ford 3000 and 5000 Tractors incorporates a breather, Figure 76. Clean the breather and change the pump oil every 300 hours.

1. Drain the pump by removing the filler plug, level plug, and drain plug, Figure 76.
2. Remove and clean the breather.
3. Install the breather and drain plug.
4. Fill the pump with clean engine oil until oil flows from the level plug hole.
5. Install the filler and level plugs.
6. Bleed the system as outlined on page 53.

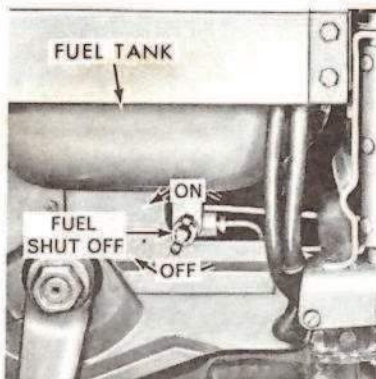
## FUEL FILTER (DIESEL)

**Draining the Filter:** Drain the diesel fuel filter every 50 hours to remove water. Drain the filter at more frequent intervals when high condensation is evident.

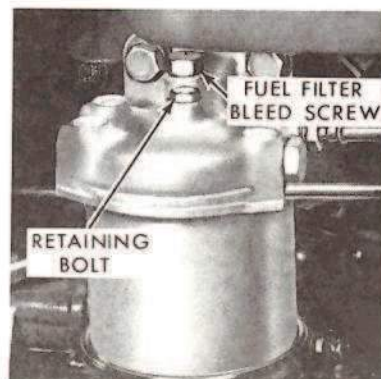
1. Be sure there is adequate fuel in the tank; then unscrew the drain plug in the base of the filter, Figure 77.
2. Allow fuel to drain until all water has been removed and only fuel flows from the filter. Close the drain plug.
3. Bleed the system as outlined on page 53.

**Changing the Filter:** Change the diesel fuel filter every 1200 hours.

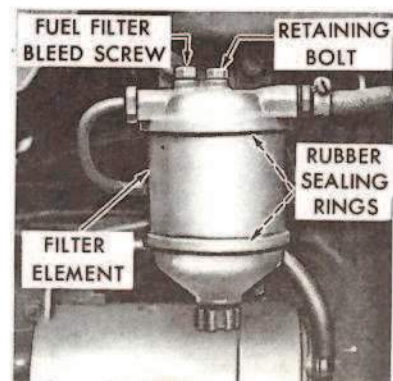
1. Close the fuel shut-off valve, Figure 78.
2. Separate the filter element from the sediment bowl and adapter by removing the retaining bolt, Figures 77, 79, 80.
3. Discard the element and sealing rings.
4. Wash the adapter and sediment bowl with a brush and clean diesel fuel.
5. Install a new element and sealing rings, taking care to prevent dirt from contacting the parts.
6. Snug down the retaining bolt. Do not overtighten, as the sealing rings may rupture.
7. Open the fuel shut-off valve so fuel will flow to the filter.



**Figure 78**  
Fuel Shut-Off Valve



**Figure 79**  
Fuel Filter Bleed Screw—  
Distributor Pump  
(Ford 2000 and 4000)



**Figure 80**  
Fuel Filter Bleed Screw  
(Ford 5000)

- Bleed the fuel filter and injection pump as covered in the following procedures:

### BLEEDING THE FUEL SYSTEM (DIESEL)

**Fuel Filter:** Bleed the fuel filter after it has been drained, if a new element has been installed, if the tractor has run out of fuel, if the lines leading to or from the filter have been disconnected, or if the injection pump has been repaired.

- Be sure there is adequate fuel in the fuel tank.
- In-Line Pump:** Loosen the fuel filter bleed screw, Figures 77 and 80, then actuate the lift pump lever, Figure 81, until air-free fuel blows from the filter. Tighten the bleed screw.

**Distributor Pump:** Loosen the fuel filter bleed screw, Figure 79. Allow the filter to bleed by gravity until air-free fuel flows from the filter; then tighten the bleed screw.

**Fuel Injection Pump:** Bleed the fuel injection pump if the tractor has run out of fuel, if a new filter element has been installed, or if the injection pump has been removed for service repairs.

- In-Line Pump:** Loosen both injection bleed screws, Figure 81; then actuate the lift pump lever until air-free fuel flows from the pump. Tighten the bleed screws.
- Distributor Pump:** Loosen the injection pump bleed screw, Figure 82. Then, with the diesel engine stop control pulled out, crank the engine until air-free fuel flows from the pump. Tighten the bleed screw.

**Injector Lines:** Bleed the injector lines if the tractor has run out of fuel, if new injectors have been installed, or if the injection pump has been removed for service repairs.

- Loosen the injector line fittings at the injectors.
- Pull the diesel engine stop control out and move the hand throttle control lever to its wide open position.
- Crank the engine until air-free fuel flows from each connection, then tighten the fittings to 18-22 lbs. ft.

**IMPORTANT:** Do not crank the engine continuously for more than 30 seconds. Doing so may cause starting motor failure.

### CLEANING THE FUEL SEDIMENT BOWL AND FILTER (GASOLINE)

Clean the gasoline fuel sediment bowl and filter every 50 hours.

- Close the fuel shut-off valve, Figure 78.
- Loosen the sediment bowl clamp, Figure 83.

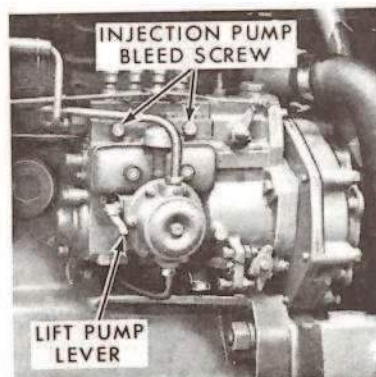


Figure 81  
Injection Pump Bleed Screw—In-Line Pump



Figure 82  
Injection Pump Bleed Screw—Distributor Pump

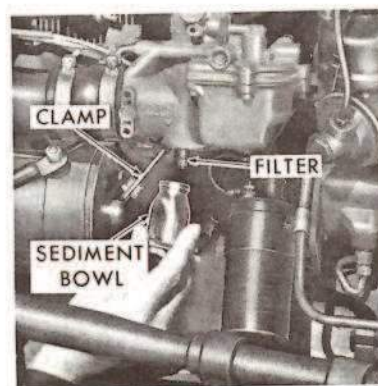


Figure 83  
Sediment Bowl Removal

- Remove the glass bowl and disc-type filter. Wash them in clean fuel.
- Check the condition of the gasket between the glass bowl and casting. Install a new gasket if necessary.
- Install the disc-type filter. Position the bowl and clamp over the filter, but do not tighten.
- Open the fuel shut-off valve and allow the bowl to fill with fuel, then tighten the clamp and screw assembly.

# LUBRICATION AND MAINTENANCE

## AIR CLEANER (OIL BATH TYPE)

**Checking Dirt Level:** Check the dirt level in the oil bath air cleaner daily or every 10 hours. Under conditions of extreme dust or chaff, check the dirt level twice daily.

1. Remove the radiator chaff screen and loosen the air cleaner bowl retaining band thumbscrew. Figure 84.
2. Remove the inner cup from the bowl and check the oil and dirt level.
3. If the dirt level is more than  $\frac{1}{4}$  inch high, service the air cleaner as outlined in the following procedure. If the dirt level is satisfactory, reassemble the cleaner and install the chaff screen.

**Changing Oil:** Change the oil in the oil bath air cleaner every 50 hours or whenever the daily or 10-hour inspection shows the dirt level to be more than  $\frac{1}{4}$  inch high.

1. Remove the radiator chaff screen and disassemble the inner cup from the outer bowl, Figure 84, as covered in the preceding procedure.
2. Discard the oil and clean the inner cup and outer bowl with solvent.
3. Place the inner cup in the outer bowl and refill with clean engine oil until level with the mark on the cup. The mark is a common level for both the cup and bowl. Fill both to the mark. Do not overfill.
4. Reassemble the cleaner and install the chaff screen.

**IMPORTANT:** When servicing the air cleaner, do not spill oil on the radiator fins. Oil on the fins will cause dirt to accumulate, blocking air passage and reducing cooling efficiency.

**Cleaning the Air Cleaner Body:** The oil bath air cleaner should be removed from the tractor, disassembled, and cleaned every 600 hours.

1. Remove the radiator chaff screen and, if equipped, the air pre-cleaner.



Figure 84  
Air Cleaner—Oil Bath Type

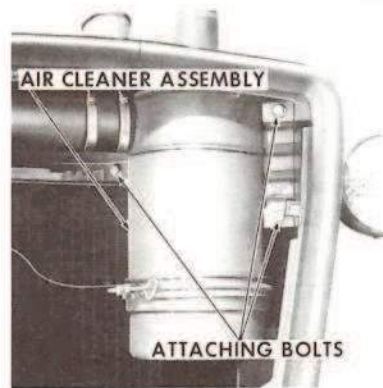


Figure 85  
Air Cleaner Assembly—  
Oil Bath Type



Figure 86  
Pre-Cleaner Bowl (Accessory)

2. Loosen the clips securing the engine air inlet pipe to the air cleaner.
3. Remove the attaching bolts that hold the air cleaner in place, Figure 85, then remove the air cleaner.
4. Remove the outer bowl and inner cup, Figure 84, and discard the oil.
5. Wash all parts in clean fuel, including the mesh screen inside the body of the air cleaner. Allow the parts to dry.
6. After cleaning, install the air cleaner body, making sure the engine air inlet pipe is correctly located and that the pipe retaining clips and air cleaner attaching bolts are tight.
7. Install the inner cup in the bowl and fill with clean engine oil until level with the mark on the cup. The mark is a common level for both the cup and bowl. Fill both to the mark. Do not overfill.
8. Install the oil-filled bowl and secure it in place with the thumbscrew.
9. Install the pre-cleaner, if equipped, and the radiator chaff screen.

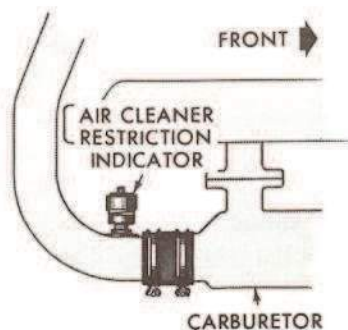
## PRE-CLEANER BOWL (ACCESSORY)

Clean the pre-cleaner bowl daily or every 10 hours. Under conditions of extreme dust, the bowl may require cleaning twice daily. The dirt level should never be allowed to accumulate above the level mark on the bowl.

1. Loosen the securing nut on top of the pre-cleaner and remove the bowl, Figure 86.
2. Remove the dirt, wipe the bowl clean and dry, and reinstall.

## AIR CLEANER (DRY ELEMENT TYPE)

**Checking the Air Cleaner Restriction Indicator:** If your tractor is equipped with the optional air cleaner restriction



**Figure 87**  
Air Cleaner Restriction Indicator  
(Optional on Gasoline Engines)

indicator, Figure 87, check the indicator daily or every 10 hours of operation.

1. Check the gauge visually. If the sight glass is completely red when the engine is *off*, reset the indicator by depressing the button on top of the indicator.
2. Clean the air cleaner element as covered in the following procedure.

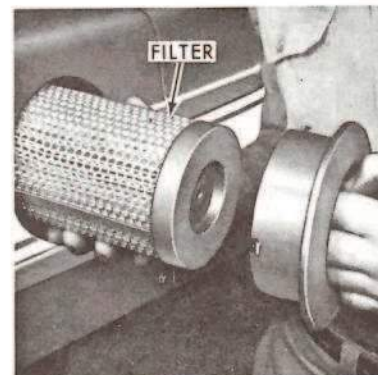
**Cleaning the Element:** Clean the dry air cleaner element every 50 hours. Under conditions of extreme dust, it is suggested that the element be cleaned every 25 hours. If your tractor is equipped with the optional air cleaner restriction indicator, clean the air cleaner whenever the sight glass is completely red when the engine is off.

1. Remove the filter element as shown in Figure 88.
2. Check the rubber seal on the end of the element for adhesion. If it is loose, install a new element. A loose, damaged, or missing seal will allow dust to enter the engine, causing severe engine wear.
3. Clean the element by tapping it against the palm of your hand. Do not beat the element against the tire or a hard surface, as damage to the element will result.

**NOTE:** Compressed air, not to exceed 100 psi, may be used for cleaning. Blow dust from the inside to the outside by inserting the nozzle inside the element. Blow loose particles from the outside by holding the nozzle at least 6 inches from the element.

4. Clean the inside of the canister with a damp, lint-free cloth, then reinstall the element.
5. Check and tighten all air induction connections before resuming operation.

**Washing the Element:** Wash the dry air cleaner element to remove exhaust smoke or film every 300 hours or after five cleanings, whichever occurs first.



**Figure 88**  
Dry-Type Air Cleaner

1. Remove the filter element as shown in Figure 88.
2. Inspect the gasket on the end of the element for damage. If the gasket is damaged or missing, install a new element.
3. Agitate the element in warm water containing a small amount of non-sudsing type detergent.

**IMPORTANT:** Do not use water hotter than the hand can stand, as the element will be damaged. Never wash the element with fuel oil, gas, or solvent. Do not oil the element.

4. Rinse the element with clean water to thoroughly loosen all foreign material. Shake excess water from the element and allow it to air dry.

**IMPORTANT:** Do not dry the element with compressed air, as the air will rupture a wet element.

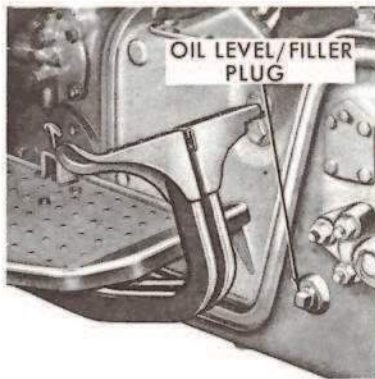
5. After drying, check for damage by holding a light inside the element. If an even fine pattern of light is seen, the element is clean and undamaged. A large spot of light indicates the element is damaged, and a new element must be installed.
6. Wipe the canister free of dust, then install the element as shown in Figure 88.

**Changing the Element:** Change the air cleaner element every 600 hours, whenever the 300-hour inspection shows the element to be damaged, or after ten cleanings, whichever occurs first.

1. Remove the filter element as shown in Figure 88.
2. Wipe the inside of the filter canister free of dust.
3. Install the new element.

#### SELECT-O-SPEED TRANSMISSION

**Checking Oil Level:** Check the Select-O-Speed oil level every 300 hours.



**Figure 89**  
Select-O-Speed Transmission  
Oil Level/Filler Plug

1. With the tractor standing level and the engine turned off, check the oil level by removing the oil level/filler plug, Figure 89, from the right side of the transmission.
2. The oil should be level with the bottom of the hole. If it is low, add new oil of the type specified, page 50, to bring the oil level up to the level/filler plug hole.
3. Install the plug.

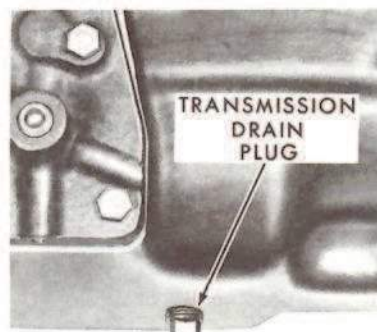
**NOTE:** Always use care to prevent foreign material from entering the transmission.

**Changing Oil Filter and Band Adjustment:** Change the Select-O-Speed oil filter every 600 hours as follows. The bands should also be adjusted at this time by your Ford Tractor-Equipment Dealer.

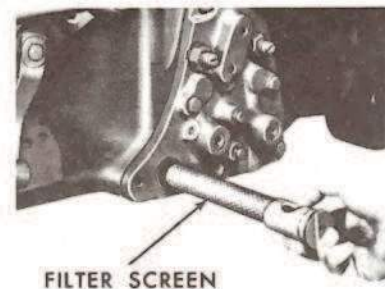
1. **Ford 5000 Only:** Drain the transmission oil into a clean container so the oil can be reused. The drain plug is located in the cover on the bottom of the case.
2. Remove the attaching bolts from the filter cover, Figure 90, that is located on the left side of the transmission case.
3. Pry the cover away from the case and remove the filter element.



**Figure 90**  
Select-O-Speed Oil Filter



**Figure 91**  
Select-O-Speed Transmission  
Drain Plug—Except Ford 5000



**Figure 92**  
Select-O-Speed Oil Inlet Screen  
—Ford 2110, 3000, 4000, and 4110

4. Install a new gasket and filter element. Be sure the element is installed so the sealing ring is toward the cover.
5. Install the cover and tighten the attaching bolts to 35-40 lbs. ft.
6. **Ford 5000 Only:** Install the drain plug and fill the transmission through the oil level/filler plug hole, Figure 89, until the oil is level with the hole. Install the plug.

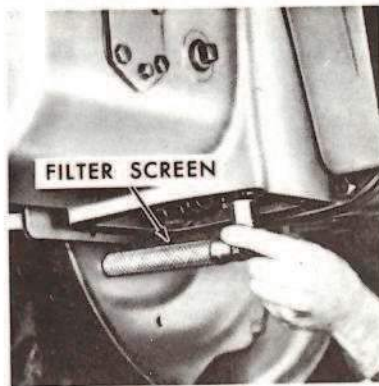
**Changing Oil and Cleaning the Inlet Screen:** Change the Select-O-Speed oil and clean the oil inlet screen every 2400 hours.

**Ford 2110, 3000, 4000, and 4110:**

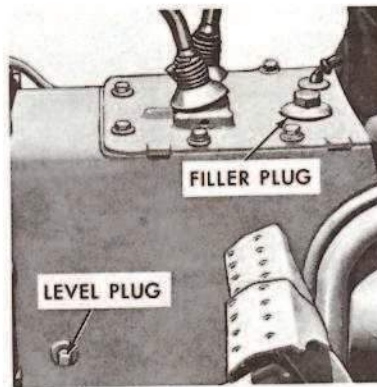
1. With the tractor standing level, drain and discard the transmission oil by removing the transmission drain plug, Figure 91.
2. Loosen the hex head bolt and retainer clip that holds the filter screen, Figure 92, in place.
3. Remove and thoroughly clean the screen.
4. Install a new O-ring on the plug end of the screen, then install the screen and secure it with the retainer clip and bolt.
5. Install the drain plug in the bottom of the transmission case.
6. Remove the oil level/filler plug, Figure 89, and fill with new oil of the type specified, page 50, until level with the hole. Install the plug.

**Ford 5000:**

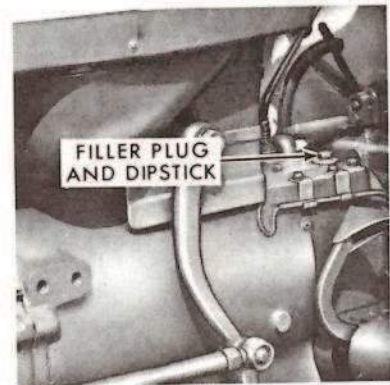
1. With the tractor standing level, drain and discard the oil by removing the transmission drain plug.
2. Remove the ten bolts that retain the cover to the bottom of the transmission case. Remove the cover.
3. Withdraw the oil inlet screen, Figure 93, from the transmission and thoroughly clean the screen.



**Figure 93**  
Select-O-Speed Oil Inlet  
Screen—Ford 5000



**Figure 94**  
Manual Transmission Oil Level  
and Filler Plugs—All Models  
Except Ford 5000



**Figure 95**  
Manual Transmission Filler Plug  
and Dipstick—Ford 5000

4. Install the screen, cover gasket, and cover. Tighten the bolts securely.
5. Install the drain plug in the bottom of the transmission case.
6. Remove the oil level/filler plug, Figure 89, and fill with new oil of the type specified, page 50, until level with the hole. Install the plug.

#### MANUAL SHIFT TRANSMISSION

**Checking Oil Level:** Check the manual shift transmission oil level every 300 hours.

##### Ford 2000, 2110, 3000, 4000, 4000 SU, and 4110:

1. With the tractor standing level and the engine turned off, check the oil level by removing the level plug, Figure 94, from the right side of the transmission case.
2. The oil should be level with the bottom of the hole. If it is low, remove the filler plug and add new oil of the type specified, page 50, to bring the oil level up to the level/filler plug hole.
3. Install the level and filler plugs.

##### Ford 5000:

1. With the tractor standing level and the engine turned off, check the oil level with the combined filler plug and dipstick, Figure 95.
2. The transmission is filled to the correct level when the oil level is midway between the end of the dipstick and the mark on the stick. If low, add new oil of the type specified, page 50. **Do not fill to the mark on the stick, as the transmission will be overfilled.**
3. Install the combined filler plug and dipstick.

**Changing Oil:** Change the manual shift transmission oil every 1200 hours.

##### Ford 2000, 2110, 3000, 4000, 4000 SU, and 4110:

1. With the transmission oil at normal operating temperature, drain and discard the oil by removing the transmission drain plug, Figure 95. Reinstall the plug after the oil has drained.
2. Remove the level and filler plugs, Figure 94, and fill the transmission with new oil of the type specified, page 50, until level with the level plug hole.
3. Install the level and filler plugs.

##### Ford 5000:

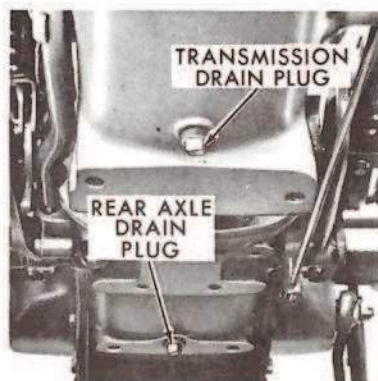
1. With the transmission oil at normal operating temperature, drain and discard the oil by removing the drain plug, Figure 97. Reinstall the plug after the oil has drained.
2. Remove the combined filler plug and dipstick, Figure 95, and fill the transmission with new oil of the type specified, page 50.
3. The transmission is filled to the correct level when the oil level is midway between the end of the dipstick and the mark on the stick. **Do not fill to the mark on the stick, as the transmission will be overfilled.**
4. Install the combined filler plug and dipstick.

#### HYDRAULIC LIFT SYSTEM (REAR AXLE)

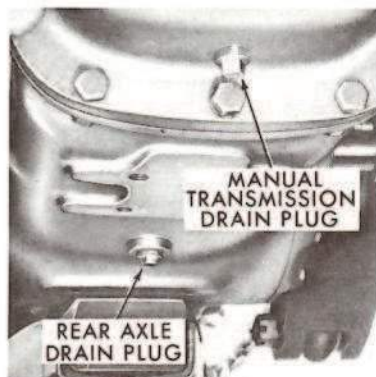
**Checking Oil Level:** Check the hydraulic system (rear axle) oil level every 50 hours.

1. With the tractor standing level, the hydraulic lift arms in the raised position, and any external cylinders retracted, check the oil level by removing the level plug. Figures 98, 99, and 100 illustrate the location of the level plugs for the various tractors.
2. The oil should be level with the bottom of the hole. If it is low, remove the filler plug and add oil of the type

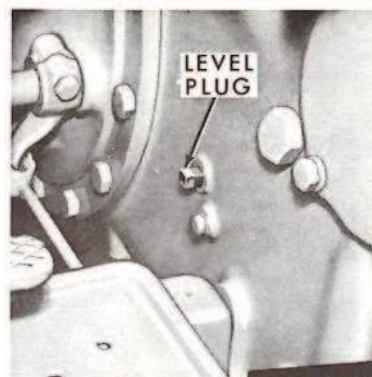
## LUBRICATION AND MAINTENANCE



**Figure 96**  
Manual Transmission and Rear Axle Drain Plugs—All Models Except Ford 5000



**Figure 97**  
Manual Transmission and Rear Axle Drain Plugs—Ford 5000



**Figure 98**  
Hydraulic System (Rear Axle) Oil Level Plug—Ford 2000, 2110, 3000, and 4110

specified, page 50, to bring the oil level up to the level plug hole. Figures 100, 101, and 102 illustrate the location of the filler plugs.

3. Install the level and filler plugs.

**Changing Oil:** Change the hydraulic lift system (rear axle) oil every 1200 hours.

1. With the tractor standing level, the hydraulic lift arms in the lowered position and any external cylinders retracted, drain and discard the oil by removing the rear axle drain plug, Figures 96, 97, and 98. Reinstall the plug after the oil has drained.
2. Remove the level and filler plugs, Figures 98 through 102, and fill the rear axle with new oil of the type specified, page 50, until level with level plug hole.

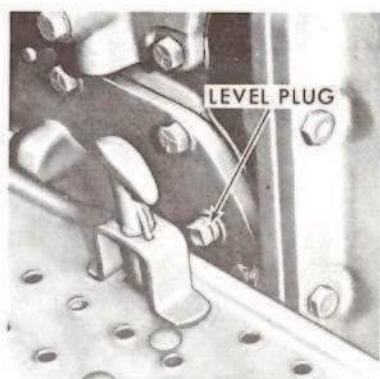
**NOTE:** Refer to the following "Winter Blend Oil Recommendations" if the tractor is to be operated at temperatures between plus 20°F. and minus 20°F.

3. Install the level plug, start the engine and fully raise the lift arms. Also extend any external hydraulic cylinders.
4. Remove the level plug and add oil as required until level with the level plug hole.
5. Install the level and filler plugs.

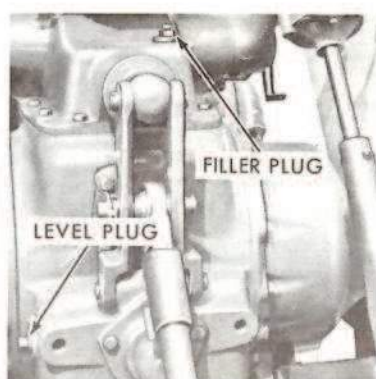
**Changing Hydraulic Oil Filters:** The hydraulic lift system oil filters (inlet and exhaust) should be changed every 2400 hours or whenever the rear axle or hydraulic lift system is overhauled. This service should be performed by your Ford Tractor-Equipment Dealer.

**"Winter Blend" Oil Recommendations:** Improved tractor hydraulic system action during cold weather (+20°F. to -20°F.) can be achieved by blending M-2C41-A oil with the specified rear axle oil, page 50.

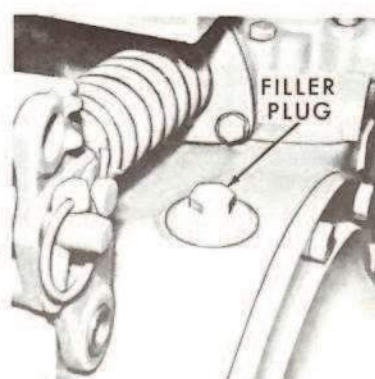
The following chart lists the quantities that should be blended to achieve improved cold weather performance. Note that the chart applies only to those tractors equipped



**Figure 99**  
Hydraulic System (Rear Axle) Oil Level Plug—Ford 4000 and 4000 SU



**Figure 100**  
Hydraulic System (Rear Axle) Oil Level and Filler Plugs—Ford 5000



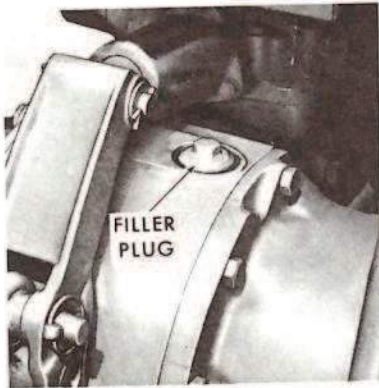
**Figure 101**  
Hydraulic System (Rear Axle) Oil Filler Plug—Ford 2000, 2110, 3000, and 4110 (Ford 2000 Shown)



**REAR AXLE AND HYDRAULIC LIFT SYSTEM  
"WINTER BLEND" OIL RECOMMENDATIONS**

(For Temperatures Between +20°F. and -20°F.)

Tractors With a Piston-Type Hydraulic Pump	Quantity		Quantity		Quantity	
	Specified Oil		Blend M-2C41-A		Total Capacity	
	U.S. Qts.	Imp. Qts.	U.S. Qts.	Imp. Qts.	U.S. Qts.	Imp. Qts.
Ford 2000, 2110, 3000, and 4110	12.5	10.4	12.5	10.4	25.0	20.8
Ford 4000	17.0	14.2	17.0	14.2	34.0	28.3



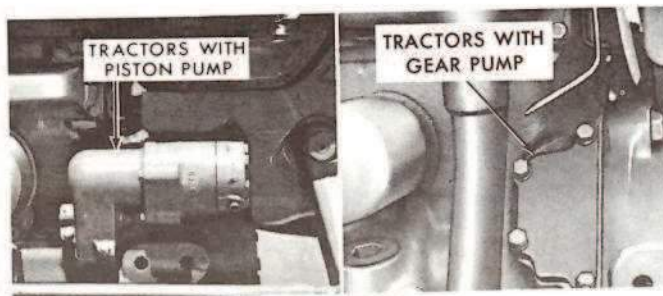
**Figure 102**  
Hydraulic System (Rear Axle) Oil  
Filler Plug—Ford 4000 and  
4000 SU



**Figure 104**  
Steering Gear Housing  
Level/Filler Plug

with a piston-type pump. Do not use "winter blend" oil in the Ford 4000, 4000 SU, and 5000 with Independent P.T.O. (gear-type pump). See Figure 103 for identification of tractors with piston pumps and gear pumps.

**IMPORTANT:** To prevent premature final drive gear wear, *DO NOT* operate the tractor with "winter blend" oil in the rear axle when temperatures are above 40°F. Also, when "winter blend" oil is used in the Ford 4000 and 4000 SU Tractors, the brakes may become noisy (squeal when applied).



**Figure 103**  
Tractor Identification—Piston Pump vs. Gear Pump

**STEERING GEAR HOUSING (MANUAL AND POWER)**

**Checking Oil Level:** Check the oil level in the manual and power steering gear housing every 600 hours.

1. Remove the sheet metal from the left side of the tractor at the base of the fuel tank to gain access to the level/filler plug, Figure 104.
2. With the tractor standing level, check the oil level by removing the level/filler plug.
3. The oil should be level with the bottom of the hole. If it is low, add new oil of the type specified, page 50, to bring the oil level up to the level/filler plug hole.
4. Install the level/filler plug and the sheet metal previously removed.

**POWER STEERING RESERVOIR**

**Checking Oil Level:** Check the oil level in the power steering reservoir every 300 hours.

1. With the engine stopped, the tractor standing level, and the wheels in the straight-ahead position, visually check

## LUBRICATION AND MAINTENANCE

the oil level in the reservoir, Figure 105, by removing the filler cap.

2. The oil should be level with the bottom of the filler neck. If low, add new oil of the type specified, page 79, and reinstall the filler cap.
3. Start the engine and turn the steering wheel from stop-to-stop several times (five or more) to purge air from the system.
4. With the wheels in the straight-ahead position, stop the engine and recheck the oil level. Add oil as required and repeat Step 3.

**Changing Oil Filter:** Change the oil filter in the power steering reservoir every 600 hours.

1. To gain access to the power steering filter, Figure 106, the pump and reservoir must be removed from the tractor. Make sure that all dirt and foreign matter is cleaned from the unit before removal. *Absolute cleanliness is essential.*
2. After removing the unit, drain the reservoir through the filler opening by inverting the assembly.
3. Separate the reservoir from the pump flange by removing the through bolt, then remove the filter.
4. Install a new filter and clean the inside of the reservoir. Also install a new O-ring on the pump-to-reservoir flange.



Figure 105  
Power Steering Oil Level Check

5. Reinstall the reservoir on the pump so the two locating lugs, Figure 106, straddle the indentation in the reservoir.
6. Install a new pump-to-engine O-ring, then install the pump on the tractor and connect the plumbing to the unit.
7. Fill the reservoir through the filler opening, Figure 105, until the oil level reaches the bottom of the filler neck.
8. Start the engine and turn the steering wheel from stop-to-stop several times (five or more) to purge air from the system.

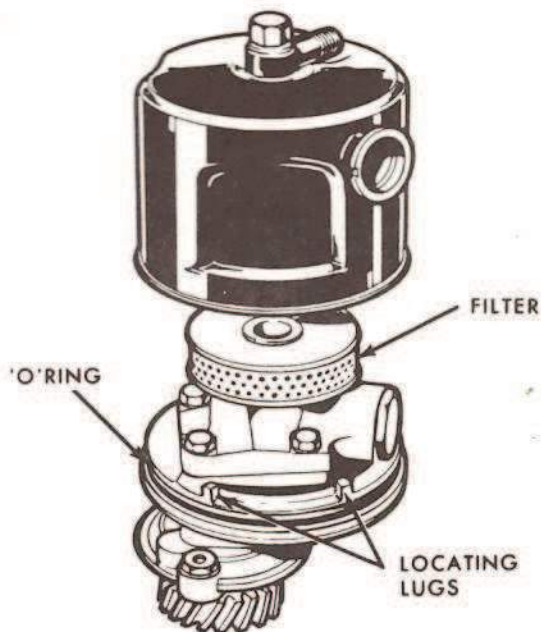


Figure 106  
Power Steering Oil Filter

9. With the wheels in the straight-ahead position, stop the engine and recheck the oil level. Add oil as required and repeat Step 8.

### BELT PULLEY (ACCESSORY)

**Checking Oil Level:** Check the oil level in the belt pulley gearbox every 50 hours.

1. With the tractor standing level and the pulley assembly positioned horizontally to the left or right, check the oil level by removing the level/filler plug, Figure 107.
2. The oil should be level with the bottom of the hole. If it is low, add new oil of the type specified, page 50, to bring the oil level up to the level/filler plug hole.
3. Install the level/filler plug.

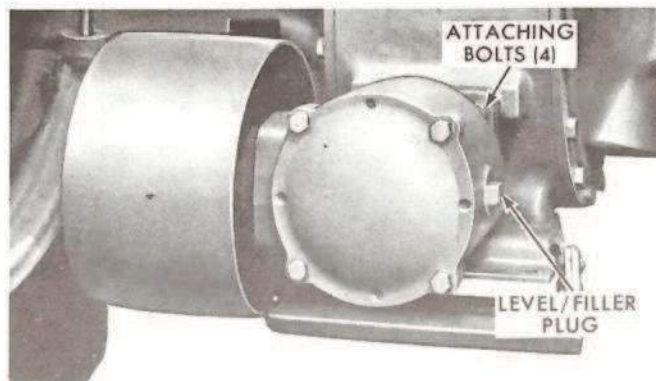


Figure 107  
Belt Pulley Level/Filler Plug

**Changing Oil:** Change the oil in the belt pulley gearbox every 1200 hours.

1. Remove the four attaching bolts, Figure 107, that retain the pulley assembly to the differential housing. Pull the assembly rearward away from the P.T.O. shaft.
2. Remove the level/filler plug from the housing. Invert the assembly to drain the oil.
3. Replace the assembly on the P.T.O. shaft so the plug hole is to the left or right. Insert one of the bolts to retain the assembly in this position.
4. Add new oil of the type specified, page 50, until the oil reaches the level plug hole.
5. Install the plug. Remove the securing bolt and install the assembly in the position required. Install and tighten the four attaching bolts.

**LUBRICATION FITTINGS**

The following lubrication points (refer to the Lubrication Charts, pages 46 and 47), require the application of a good quality grease every 50 hours. In extremely dirty conditions, lubrication should be made more often. Refer to page 50 for the type of grease that should be used.

- Front Wheel Spindles.
- Brake and Clutch Pedal Pivots.
- Power Steering Cylinder(s) (Except Ford 5000).
- Steering Center Arm Pivot (Ford 5000).
- Differential Lock Pedal Pivots.
- Hydraulic Lift Linkage.

1. Wipe away all old grease and dirt from the lubrication fittings to prevent dirt or foreign material from entering the fittings when new grease is applied.
2. Use a high pressure grease gun to force in the new grease until clean grease oozes from the assembly being lubricated.

**GENERAL MAINTENANCE**

**COOLING SYSTEM**

**Checking Coolant Level:** To obtain maximum efficiency and service life from the engine, it must operate at the correct temperature. This is dependent on the cooling system. The system should be kept filled with clear water with a rust inhibitor or antifreeze solution.

If the antifreeze does not contain a rust inhibitor, then one should be added. Check the coolant level daily or every 10 hours.

1. Remove the radiator cap and check the level of the coolant.



**CAUTION:** *The cooling system operates under pressure which is controlled by the radiator cap. It is dangerous to remove the cap while the system is hot. Always cover the cap with a thick cloth and turn the cap slowly to the first stop. Allow all pressure to escape before removing the cap completely.*

2. If the coolant level is more than 1 to 1½ inches below the bottom of the filler neck, add clean water or anti-freeze solution as necessary. If the cooling system already contains antifreeze, add only antifreeze solution of the correct water/antifreeze mixture. Plain water will dilute the solution and weaken its protection.

**IMPORTANT:** *Alcohol-type antifreeze is not recommended. Do not mix alcohol-type solution with permanent or long-life types of antifreeze.*

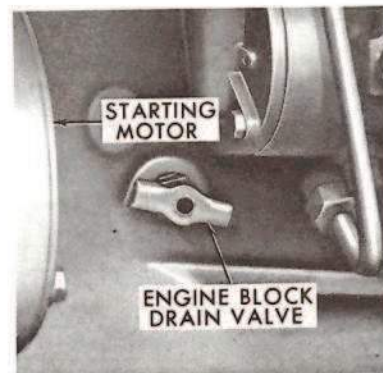
3. Keep the radiator fins clear of chaff or dirt to allow free passage of air.

**Draining and Flushing the Cooling System:** Drain and flush the radiator and engine block every 6, 12, or 24 months as indicated below:

- Plain Water . . . . . Drain, flush, and refill every 6 months; add rust inhibitor
- Permanent Antifreeze (Regular Ethylene Glycol) . . . . Change every 12 months
- Long-Life (Ford) Antifreeze . . . . . Change every 24 months

To drain the system:

1. Remove the radiator cap and open the drain valve at both the radiator and the engine block. The radiator drain valve is located on the bottom left side of the



**Figure 108**  
**Engine Block Drain Valve**



**Figure 109**  
Breather Vent—Ford 5000  
Gasoline

radiator. The engine block drain valve is located in front of the starting motor on the right side of the engine. See Figure 108.

After the coolant has drained, run water through the system with the engine running by placing a water hose in the radiator filler neck. When the water flowing from the drain valves is free of discoloration and sediment, remove the hose and stop the engine.

3. Close the two drain valves and slowly refill the system with an antifreeze solution or with water that contains a rust inhibitor. Fill until the coolant is approximately 1 to 1½ inches below the bottom of the filler neck.

**NOTE:** When filling the radiator on Ford 5000 Tractors with a gasoline engine, open the breather on top of the intake manifold, Figure 109. Close the breather when coolant flows from the vent.

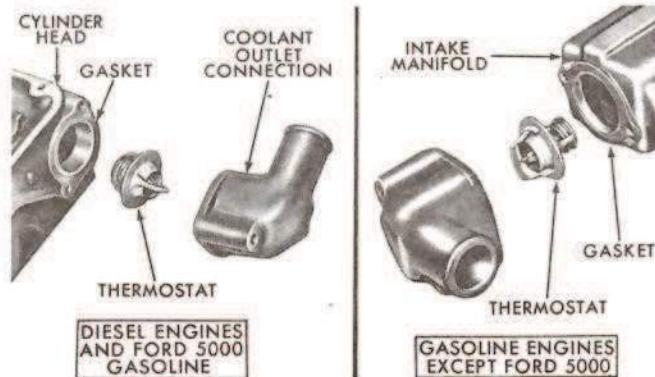
**IMPORTANT:** If plain water is used, be sure to add rust inhibitor to prevent corrosion of the water pump seal.

4. Clean the radiator cap and cap seal. Install the cap.
5. Run the engine until normal operating temperature is reached, then stop the engine and recheck the coolant level. Add coolant as required.

**IMPORTANT:** Never run the engine when the cooling system is empty, and do not add cold water or cold antifreeze solution if the engine is hot.

**Thermostat:** The thermostat on all diesel engines and on the Ford 5000 gasoline engine is located in the coolant outlet connection in the front of the cylinder head. See Figure 110.

The thermostat on all gasoline engines (except the Ford 5000) is located in the coolant outlet connection on the front of the intake manifold. See Figure 110.



**Figure 110**  
Engine Thermostats

When the engine is cold, the thermostat, which is a temperature sensitive valve, shuts off the flow of coolant to the radiator, allowing rapid engine warm-up. A recirculating bypass allows the coolant to circulate within the engine whenever the thermostat shuts off flow to the radiator.

**IMPORTANT:** Do not remove the thermostat in an attempt to improve the cooling. This will cause the engine to run below normal working temperatures, resulting in excessive engine wear.

If it ever becomes necessary to install a new thermostat, it should be positioned in the recess of the water outlet connection so the heat element (spring end) will be in the cylinder head of diesel engines and the Ford 5000 gasoline engine (intake manifold on all other gasoline engines). See Figure 110.

**Fan Belt:** A belt-driven fan at the front of the engine draws air through the fins of the radiator to cool the coolant in the radiator. A slipping fan belt will lower the efficiency of the fan, resulting in the engine running too hot. If the belt is too tight, it will shorten the generator bearing life. A correctly tightened belt will deflect ¼ to ½ inch when a 60 to 90 pound force is applied midway between the belt pulleys. Check the condition and tension of the fan belt every 300 hours. If the belt shows signs of cracking or fraying, install a new belt.

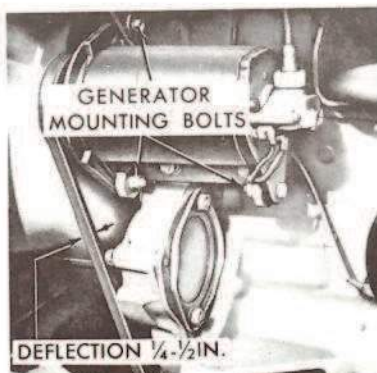
**To Adjust Belt Tension:**

1. Loosen the three generator mounting bolts, Figure 111.

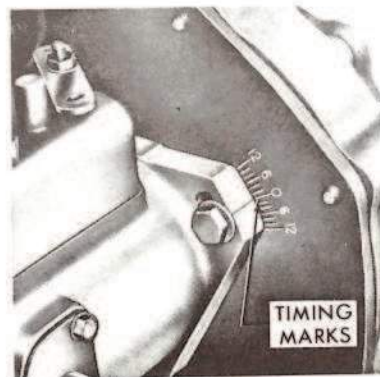


**CAUTION:** Never attempt to loosen or tighten the generator mounting bolts when the engine is running.

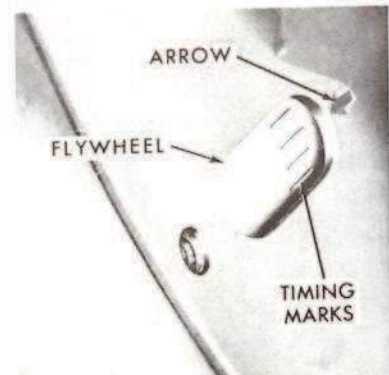
2. Pry the generator away from the engine and tighten the mounting bolts.
3. Recheck belt deflection.



**Figure 111**  
Generator/Fan Belt Tension



**Figure 112**  
Distributor Injection Pump  
Timing Marks



**Figure 113**  
Flywheel Inspection Hole

### TIMING FUEL INJECTION PUMP

The fuel injection pump should never be disassembled or adjusted without specialized training and equipment. Consult your Ford Tractor-Equipment Dealer if any internal repairs or adjustments become necessary. The pump timing can, however, be checked and adjusted as follows:

**Distributor-Type Pump:** The injection pump is correctly timed to the engine when the mark on the pump mounting flange is aligned with the zero mark on the engine front mounting plate, Figure 112. If the marks are not aligned, loosen the injection pump mounting bolts, rotate the pump to align the marks, and retighten the bolts.

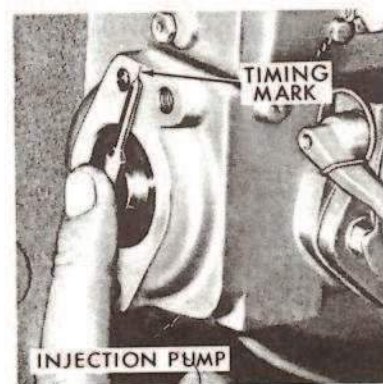
**IMPORTANT:** Do not crank the engine when the pump mounting bolts are loose. Also, if the pump is removed, and then reinstalled, make sure the pin in the drive gear (not shown) is aligned with the slot in the pump drive hub before tightening the mounting bolts.

**In-Line Type Pump:** The injection pump is correctly timed to the engine when fuel injection at the No. 1 piston occurs 19° btdc on the compression stroke. Determine correct timing as follows:

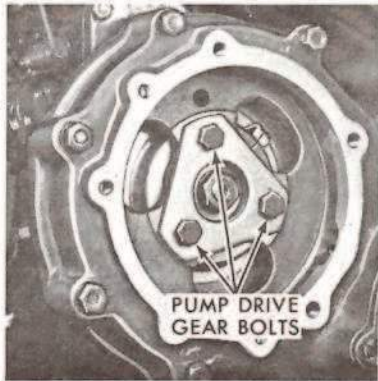
1. Remove the flywheel inspection cover from the right rear of the engine to expose the inspection opening, Figure 113. Also remove the cover and gasket from the rear of the injection pump. Figure 114.
2. With the diesel engine stop control pulled out, rotate the flywheel by "bumping" the starter with the key-starter switch until the timing marks, Figure 113, can be seen on the flywheel.
3. Using a screwdriver through the inspection cover opening, continue to turn the flywheel until the 19° btdc mark is aligned with the arrow. The No. 1 piston should now be at 19° btdc on its compression stroke.

**NOTE:** If the arrow on the end of the pump camshaft is pointing away from the timing mark on the pump, Figure 114, and the 19° btdc mark is centered, the piston is on its exhaust stroke. If this is the case, rotate the flywheel 360° (one full turn) until the 19° btdc mark is again aligned with the arrow, Figure 113.

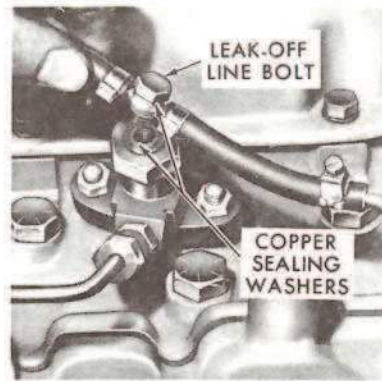
4. After positioning the No. 1 piston at 19° btdc on the compression stroke, place a pointer in the V-notch of the pump camshaft as shown in Figure 114. If the pointer does not align with the timing mark, the pump is not correctly timed to the engine and should be retimed as outlined in Steps 5 through 8.
5. Drain the coolant from the radiator and remove the lower hose.
6. Remove the inspection plate and gasket from the front of the engine to expose the pump drive gear bolts, Figure 115.
7. Loosen the pump drive gear bolts and rotate the pump until the pointer, Figure 114, aligns with the timing mark.



**Figure 114**  
In-Line Injection Pump Timing  
Mark



**Figure 115**  
In-Line Injection Pump  
Adjustment Bolts



**Figure 116**  
Removing Injector Leak-Off Lines



**Figure 117**  
Injector and Sealing Washers

8. Tighten the pump drive gear bolts, and install all covers, gaskets, and plates previously removed. Install the radiator lower hose and fill the radiator.

### FUEL INJECTOR REMOVAL AND INSTALLATION

The injectors should be cleaned, tested, and adjusted every 600 hours. Do not disassemble or adjust the injectors yourself. Remove them from the tractor and have them serviced by your Ford Tractor-Equipment Dealer.

#### To remove the injectors:

1. Remove the battery tray locating bolt and swing the battery tray outward to gain access to the injectors.
2. Clean all loose dirt from around the injectors and lines. Disconnect the leak-off lines from the injectors as shown in Figure 116. Discard the copper sealing washers.
3. Disconnect the injection pump lines at the pump and injectors. Cover the ends of the lines and the injector inlet and leak-off ports to prevent the entry of dirt. See Figure 117.
4. Unscrew the two retaining nuts from each injector and remove the injectors. Discard the dust sealing washers.
5. Remove and discard the copper injector sealing washers from the injector locating bores. If a spare set of injectors is not immediately available, cover the bores to prevent the entry of dirt.

#### After the injectors have been serviced, install them as follows:

1. Place new dust sealing washers around the injector body.
2. Install a new copper sealing washer in each injector locating bore. Install the injectors and tighten their retaining nuts to 10-15 lbs. ft.

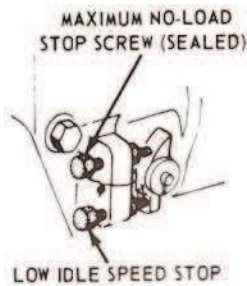
**IMPORTANT:** Do not overtighten the retaining nuts or you may distort the injector.

3. Install the injector lines. Tighten the fittings at the injectors finger tight until after bleeding the lines. Tighten the fittings at the injection pump to 18-22 lbs. ft.
4. Install the leak-off line, using new copper sealing washers above and below each connection, Figure 116. Tighten the leak-off line bolts to 8-10 lbs. ft.
5. Bleed the injector lines as covered under "Injector Lines," page 53.
6. After bleeding the lines, swing the battery back into position and secure it with the locating bolt.

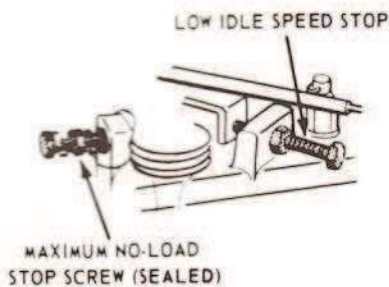
### DIESEL ENGINE SPEED ADJUSTMENTS

The maximum no-load and idle speeds of the engine are set by adjustments on the pump. The maximum no-load speed stop screw is set and sealed at the factory and should only be adjusted by a qualified diesel mechanic at your Ford Tractor-Equipment Dealer. If the maximum speed of the engine is not within the range shown below, check for correct throttle linkage adjustment as outlined in the following procedure.

- Ford 2000, 2110, and 3000 . . . . . 2225-2275 rpm no-load
  - Ford 4000, 4000 SU, and 4114 . . . 2425-2475 rpm no-load
  - Ford 5000 . . . . . 2325-2375 rpm no-load
1. Warm the engine to normal operating temperature, then stop the engine.
  2. Disconnect the throttle linkage at the bellcrank and move the hand throttle lever to the wide-open position.
  3. Pull the throttle linkage rod toward the bellcrank far enough to bring the control stop on the injection pump back against the sealed maximum no-load stop screw.



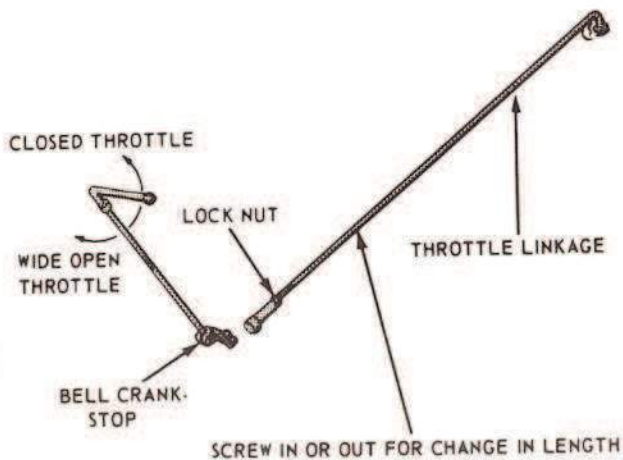
**In Line Pump — Ford  
3000 and 5000**



**Distributor Pump — Ford  
2000, 2110, 4000, 4000 SU, and 4110**

To prevent a false setting, **do not pull excessively on the control rod.**

4. Hold the rod in the maximum speed position as in Step 3, and adjust it to fit the distance between the bellcrank and pump while maintaining the hand throttle in the wide-open position as in Step 2.
5. Connect the rod to the bellcrank and tighten the jam nut.

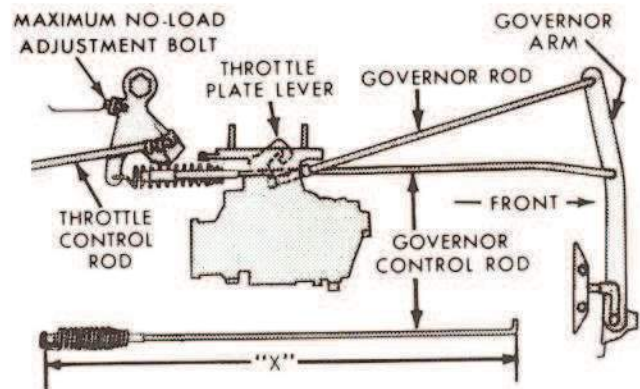


6. Start the engine and check for proper maximum no-load speed. The engine should be running at the correct speed. If it is not, the sealed maximum no-load speed stop screw should be adjusted by your Ford Tractor-Equipment Dealer.
7. After obtaining the correct maximum no-load speed, move the hand throttle lever to the idle position. Loosen the lock nut on the idle speed stop and adjust the stop to obtain 600-700 rpm. Tighten the lock nut.

### GASOLINE ENGINE SPEED ADJUSTMENTS

Constant engine speed for any given throttle setting is provided by a centrifugal governor located in the engine front cover. This governor is driven by the engine timing gears, and connected by suitable linkage to the throttle plate on the carburetor. Adjust as outlined below.

1. With the engine stopped, move the hand throttle to the wide-open position.
2. Remove the right-hand steering gear sheet metal cover.
3. Loosen the jam nut on the governor rod and disconnect the rod from the throttle plate lever at the carburetor.
4. Rotate the carburetor throttle plate lever to the full-open position so the wide-open throttle tang on the lever is against the stop on the carburetor.
5. With the governor arm fully rearward (wide-open), and the throttle plate fully open, adjust the governor rod length to meet the throttle plate lever, then lengthen the rod by turning the clevis one additional turn. Connect the rod to the lever and tighten the jam nut.
6. Move the hand throttle to the closed position.

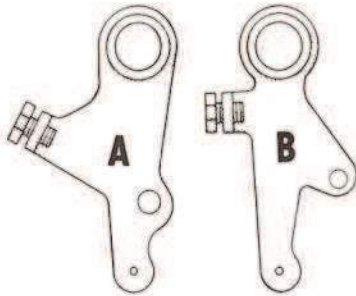


7. Remove the governor control rod by disconnecting it from the governor arm and governor control lever.

## LUBRICATION AND MAINTENANCE

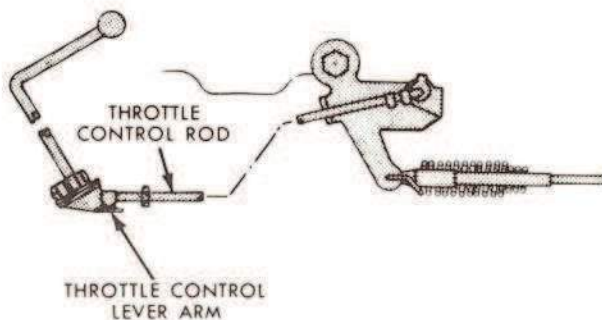
8. If your tractor is equipped with a governor control lever like that shown at "A" below, adjust the governor control rod "X" dimension to 11-25/32 inches. Adjust the rod to 12-25/32 inches if your tractor has a lever like that shown at "B". Reinstall the rod after making the adjustment.

**NOTE:** Adjust the "X" dimension to 17-3/16 inches on all Ford 5000 Tractors.



Governor Control Lever Identification

9. With the hand throttle in the closed position, loosen the jam nut on the throttle control rod, then disconnect the rod from the throttle control lever arm.
10. Push the throttle control rod fully forward (idle position) and adjust its length to meet the attachment point on the throttle control lever arm, then lengthen the rod by turning the clevis two full turns. Connect the rod to the arm and tighten the jam nut.



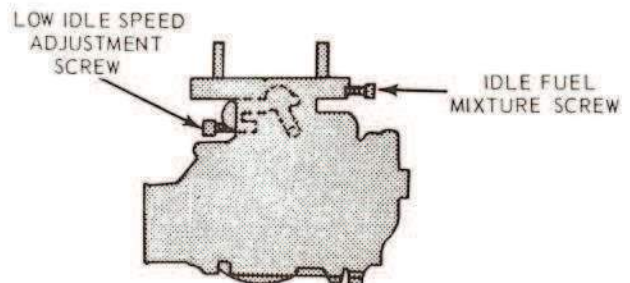
11. Start the engine and allow it to run until it reaches normal operating temperature, then adjust the low idle adjustment screw in or out until the engine maintains 600-700 rpm.
12. Adjust the idle fuel mixture screw in or out until the engine reaches its highest idle rpm, then recheck the low idle speed and readjust if necessary.

13. Move the hand throttle to the wide-open position. Check the rpm as indicated on the Proof-Meter, and if necessary, turn the maximum no-load speed adjustment to achieve the recommended maximum no-load speed:

- Ford 2000 and 2110 . . . . . 2065-2165 rpm no-load
- Ford 3000 and 5000 . . . . . 2285-2385 rpm no-load
- Ford 4000, 4000 SU, and 4110 . . . . . 2395-2495 rpm no-load

14. Tighten the adjustment bolt lock nut, then move the hand throttle to the idle position and recheck the low idle speed. Readjust if necessary.

15. Stop the engine and install the right-hand steering gear sheet metal cover.



### FOOT THROTTLE ADJUSTMENT

Ford 2110 and 4110:

If the engine rpm will not return to low idle speed when the hand throttle is closed, check the injection pump (or carburetor) settings for proper adjustment. If further adjustment is necessary to obtain the specified low idle speed, tighten the adjuster nut, insert, Figure 118, until the throttle closes correctly.

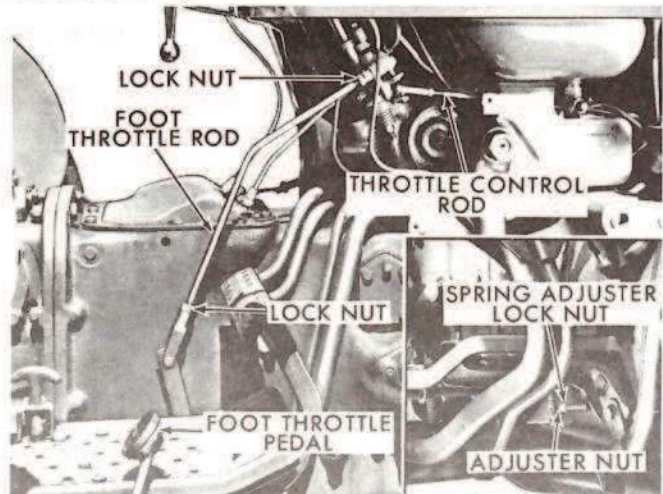


Figure 118  
Foot Throttle Adjustment—Ford 2110 and 4110



If the foot and hand throttles are malfunctioning, adjustment can be made as follows:

1. Remove the right-hand steering gear sheet metal cover.
2. Loosen the lock nuts at the top and bottom of the foot-operated throttle rod, Figure 118, and remove the clevis pin.
3. Adjust the length of the throttle rod so the foot pedal touches the foot plate, at the same time the throttle disc hits the stop plate on the steering column. The throttle control rod should then be adjusted so the throttle lever on the injection pump (or carburetor) is touching the maximum speed stop screw.
4. Reconnect the foot-operated throttle rod, install the clevis pin and secure with a new cotter pin. Tighten the throttle rod lock nuts.
5. Start the engine and allow it to run until it reaches normal operating temperature.
6. Recheck both throttles and readjust as necessary.
7. Install the right-hand steering gear sheet metal cover.

#### DISTRIBUTOR POINTS

Install new distributor points every 600 hours. If the points are dirty, pitted, or set incorrectly, engine misfiring and loss of power will result. In such circumstances, the point gap should be reset or new points installed. The following procedure covers the installation of new points. To reset the point gap only, omit Steps 3 through 6. Badly burned or pitted points can be caused by a faulty condenser, oil having reached the parts, or prolonged use.

1. With the key-starter switch in the "OFF" position, remove the distributor primary lead from the coil "DIST" terminal. This will prevent coil damage if the engine is cranked with the key-starter switch "ON" when adjusting the point gap.
2. Remove the distributor cap, rotor, and dust cover, Figure 119.
3. Loosen the screw that connects the condenser wire and primary wire to the breaker point assembly.
4. Remove the screws and lock washers that hold the distributor points to the breaker plate. Remove the points. It is recommended that a new condenser be installed when new points are installed. Remove the screw and lock washer securing the condenser to the breaker plate.
5. Install new points (and condenser) on the breaker plate. Tighten the screws.
6. Attach the condenser lead and the primary wire to the breaker point assembly.

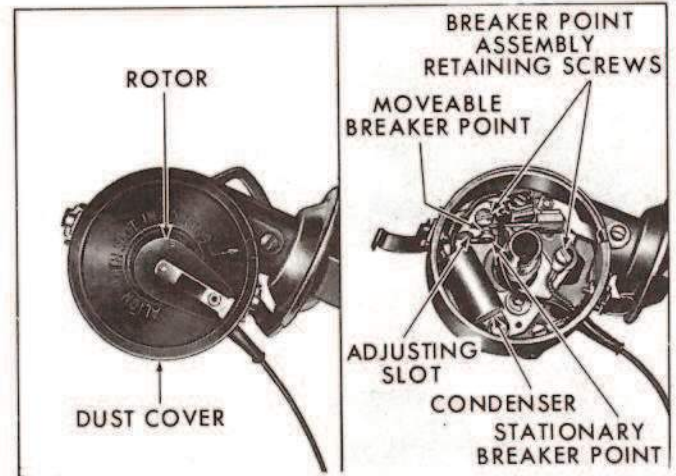


Figure 119  
Changing Distributor Points

7. With the key-starter switch, rotate the cam so the distributor points are closed. Check the alignment and, if necessary, bend the stationary breaker point bracket.
8. To adjust the points, crank the engine until the rubbing block on the moving contact is on the high point of a distributor cam lobe.
9. Slightly loosen the two point assembly retaining screws. Insert a screwdriver in the adjustment slots and rotate until the specified gap (0.022 to 0.028 inch) is obtained. Check the gap with a blade-type feeler gauge.
10. Tighten the retaining screws and recheck the gap. Repeat the procedure if the point gap changed while tightening the adjusting screws.
11. Install the rotor, dust cover, and distributor cap.
12. With the key-starter switch "OFF," connect the distributor primary lead to the coil "DIST" terminal.

#### IGNITION TIMING

Ignition timing can be checked and adjusted as follows:

1. Remove the flywheel inspection cover at the right rear of the engine, Figure 113.
2. Disconnect the vacuum line from the advance mechanism on the distributor.
3. Connect the timing light to the engine with the high tension lead on the No. 1 spark plug lead and the other two leads on the proper battery terminals.
4. Start the engine and run it at idle speed (600-700 rpm). Direct the timing light so it flashes on the flywheel inspection opening. If the timing is not at  $2^\circ \pm 2^\circ$  btdc, loosen the distributor timing clamp bolt, Figure 120, and rotate the distributor as required. Tighten the clamp bolt to maintain the adjustment.

# LUBRICATION AND MAINTENANCE

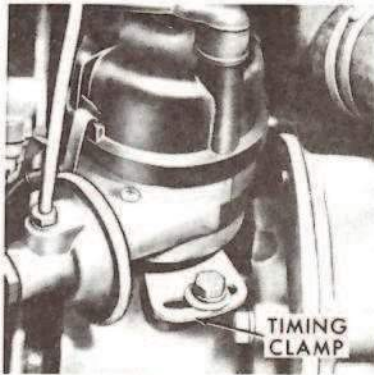


Figure 120  
Distributor Timing Clamp

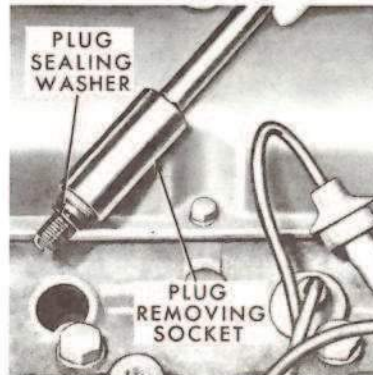


Figure 121  
Removing Spark Plugs

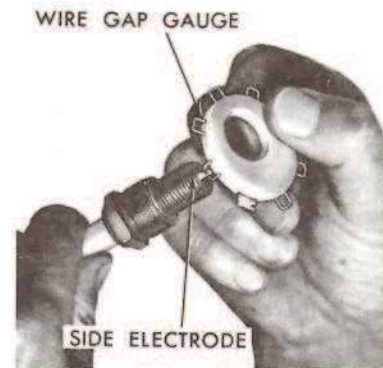


Figure 122  
Checking Spark Plug Gap

5. Remove the timing light leads and connect the vacuum line to the distributor.
6. Install the flywheel inspection cover.

## SPARK PLUGS

To maintain engine efficiency and performance, clean the spark plugs every 300 hours and install new plugs every 600 hours.

1. To gain access to the spark plugs, loosen the battery tray wing nut and swing the battery outward.
2. Remove the distributor-to-spark plug wires from the plugs.

**IMPORTANT:** Do not pull on the wires. Pry the protective boots from the plugs, then pull on the boots. Twisting the boot will usually loosen it on the plug.

3. Using a spark plug socket, remove the spark plugs, Figure 121, and inspect for damaged insulators, fouling, and excessive electrode erosion. If serviceable, clean with sandblasting equipment.
4. Check the gap with a wire gauge, Figure 122. Adjust the gap to 0.023-0.027 inch. Keep the outside of the spark plugs and leads clean by wiping away any oil, grease, or dirt. If the spark plugs are in poor condition, new plugs should be installed regardless of service hours operated.
5. Install the plugs and tighten them to 26-30-lbs. ft. Connect the wires and move the battery back into position. Tighten the battery tray wing nut.

## VALVE CLEARANCE (LASH)

Correct valve clearance is one of the most important factors of good engine performance. Excessive clearance will cause the engine to operate excessively noisy, and insufficient clearance will cause poor performance. Because of this, it is extremely important that care be used when adjusting valve clearance.

**Checking and Adjusting Valve Clearance:** Check and adjust the valves every 600 hours.

1. Run the engine at idle speed for 10 to 30 minutes to be sure normal operating temperature is obtained.
2. Loosen the battery tray wing nut and swing the battery outward.
3. Remove the rocker arm cover.
4. With the engine idling, check the clearance of each valve with a step-type feeler gauge, Figure 123.

The setting should be:

Intake .....	0.014 go — 0.016 no-go
Exhaust .....	0.017 go — 0.019 no-go

5. If the clearance is incorrect on any valve, turn the adjusting screw at the push rod end of the valve rocker arm either into or out of the arm while checking for correct clearance with the step-type feeler gauge.
6. Install the rocker arm cover. Use a new gasket if the old one is damaged. Tighten the cover bolts evenly.
7. Move the battery back into position and tighten the wing nut.

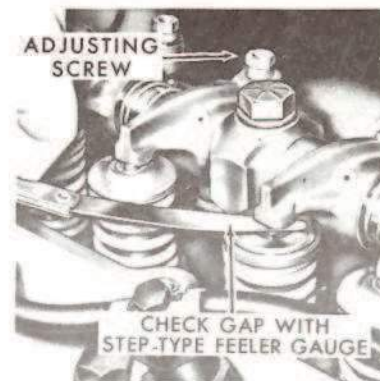


Figure 123  
Checking Valve Clearance

## BATTERY

Keep the battery connections tight and free of corrosion. An ammonia or baking soda-water solution is good for washing the outside surface and terminals of the battery. Make sure the solution does not enter the battery. After cleaning, wash the battery with clear water. Protect the terminals from corrosion with a light application of petroleum jelly.

In freezing temperatures, the battery must be maintained in a good state of charge. When a battery is discharged or run down, the electrolyte is weak and may freeze, damaging the case. If it becomes necessary to add water (distilled), it should be done just before using the tractor so the charging will mix the water with the electrolyte and prevent the water from freezing.

Determine the battery charge by checking the specific gravity of the electrolyte. Note in the following chart how the state of charge decreases when the specific gravity decreases.

State of Charge	Specific Gravity Temperate Climates	Specific Gravity Tropical Climates
Fully Charged	1.280	1.225
75%	1.230	1.180
50%	1.180	1.135
25%	1.130	1.090
Discharged	1.080	1.040

**Checking Electrolyte Level:** Check the electrolyte level in the battery every 50 hours.



**CAUTION:** *When the generator is charging, an explosive gas is produced inside the battery; therefore, always check the electrolyte level with the engine stopped. Do not use an exposed flame and do not smoke when checking the battery.*

1. Clean the top of the battery, then remove the vent plugs.
2. If the electrolyte level is low, **add distilled water**. The level is correct when the liquid just covers the ring in the filler wells; the top of the red shield; or 1/4-inch above the plates, depending on the type of battery.

**NOTE:** *Keep distilled water in a clean, well covered, non-metallic container.*

3. Install the vent plug after making sure the breathing holes are not blocked. At below freezing temperatures, be sure to run the engine for a period of time, after

adding water, so the battery will charge and prevent the water from freezing.

## GENERATOR AND REGULATOR

The generator is belt-driven from the engine crankshaft pulley. It is important that belt slippage does not occur, otherwise the charging rate will be affected. Details of belt adjustment are given on page 62.

The only maintenance on the generator is to periodically inspect the wiring connections and keep them clean and tight.

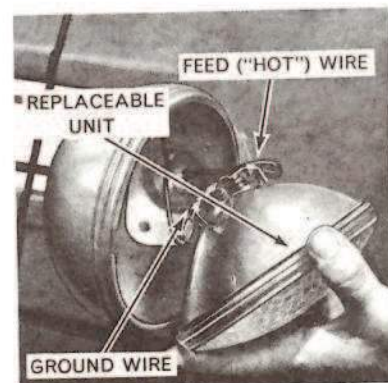
A voltage regulator automatically controls the generator charging rate. No attempt should be made to adjust the setting of the regulator unit. It is a sealed unit and cannot be adjusted.

If the charge indicator light indicates that the generator is not charging the battery, check the fan belt and the wiring connections. If these are satisfactory and the warning light continues to indicate no charge, consult your Ford Tractor-Equipment Dealer.

## SEALED BEAM HEADLAMPS

Should a headlamp failure occur, the sealed beam unit must be replaced. To change the sealed beam unit:

1. Remove the headlamp rim locking screw, spread the rim, and remove it.
2. Remove the sealed beam unit from the lamp housing, as shown in Figure 124.
3. Loosen the wiring connections and discard the unit.
4. Install the new sealed beam unit making sure the wiring connections are tight; that the top of the unit is up; and that the locating tab is positioned in the slot.
5. Install the rim and tighten the rim locking screw.



**Figure 124**  
Changing Sealed Beam Headlamp

## LUBRICATION AND MAINTENANCE

### TAIL LAMP AND FLASHER WARNING LAMP

To replace a tail lamp bulb or flasher warning lamp bulb:

1. Remove the lens and/or rim assembly, then remove the bulb.
2. Install a new bulb and reinstall the lens and/or rim assembly.

### INSTRUMENT LIGHTS

To change an instrument bulb:

1. Remove the screws that secure the instrument panel to the rear hood panel assembly and pull the instrument panel rearward.
2. If necessary, disconnect the Proof-Meter drive cable to obtain better access.
3. Remove the bulb socket from the rear of the instrument panel and install a new bulb.
4. Reassemble in the reverse order.

### TIRES

Check tire pressures every 50 hours, or weekly. Refer to the "Tire Inflation Vs. Permissible Load" Chart on page 43, for the air pressures that should be used.

**NOTE:** *If the rear wheels are weighted with liquid ballast, a special tire gauge should be used because the calcium chloride and water will cause corrosion in the standard-type gauge.*

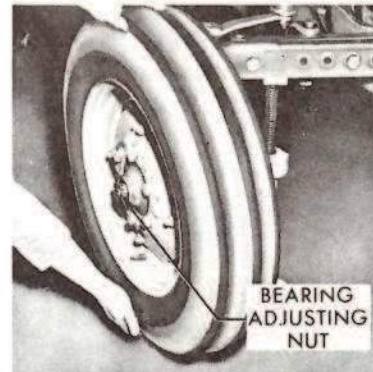
When checking tire pressures, inspect the tire for damaged side walls and tread cuts. Neglected damage will lead to early tire failure.

### FRONT WHEEL BEARINGS

The front wheels are carried on the wheel spindles by inner and outer tapered roller bearings. A grease seal is provided at the inner end of the spindle, and a hubcap at the outer end, to retain the lubricant and to keep out dirt and other foreign material.

Front wheel bearings should be repacked every 600 hours as follows:

1. Apply the parking brake to hold the tractor securely.
2. Jack up one of the front wheels and remove the hubcap, the cotter pin, and the nut, Figure 125. Remove the thrust washer, outer bearing, and then the complete wheel assembly.
3. Remove the grease retainer from the rear of the hub and the inner bearing from the wheel.



**Figure 125**  
**Servicing Front Wheel Bearings**

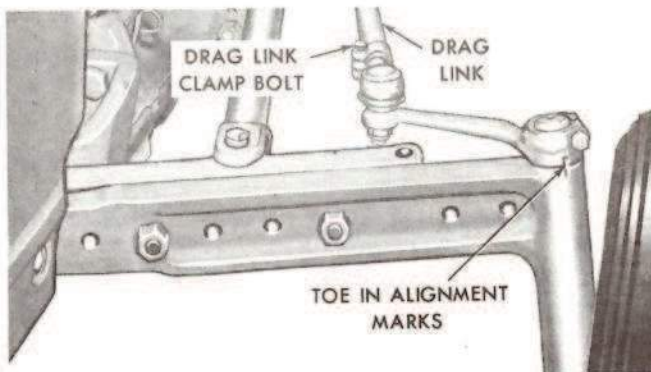
4. Thoroughly clean all parts in a suitable solvent and allow to dry naturally. Do not use compressed air. Inspect the bearing cone and roller assemblies for excessive discoloration or wear of the rollers; similarly, check the bearing cups.
5. Repack the cones with clean, short-fiber grease. Pack approximately ¼-inch of grease in the space between the bearing cups in the hub, but do not pack the hub completely. Apply a film of grease on the surface of the spindle.
6. Reinstall the inner bearing and install a new grease retainer in the rear of the hub.
7. Place the wheel assembly on the spindle and install the outer bearing, thrust washer, and castellated nut. Tighten the nut, at the same time turning the wheel, until a slight drag is felt. Back off the nut until the nearest slot in the nut lines up with the hole in the spindle. Install a new cotter pin, then the hubcap.

### FRONT WHEEL TOE-IN

Front wheel toe-in adjustments on your tractor were made at the factory. Normally, the wheels maintain their toe-in; however, an occasional check should be made. If the alignment marks, Figures 126 and 127, do not line up, the toe-in is incorrect. Check for correct toe-in as follows:

#### Checking Toe-In

1. With the front wheels in the straight-ahead position, mark the front of the wheels (not the tires) at wheel hub height. Determine the straight-ahead position by turning the steering wheel from lock to lock and then halfway back.
2. Measure and record the distance between the front of the wheels at the marks, then push the tractor forward or backward until the marks are at wheel hub height on the rear of the wheels.



**Figure 126**  
**Toe-In Alignment Marks—Ford 2000, 2110, 3000, 4000 SU,**  
**and 4110**

3. Measure and record the distance between the rear of the wheels at the marks.
4. The difference between the dimensions recorded in Steps 2 and 3 should give zero to 1/2 inch toe-in.
5. If the toe-in is not correct, adjust as outlined in the applicable paragraph that follows:

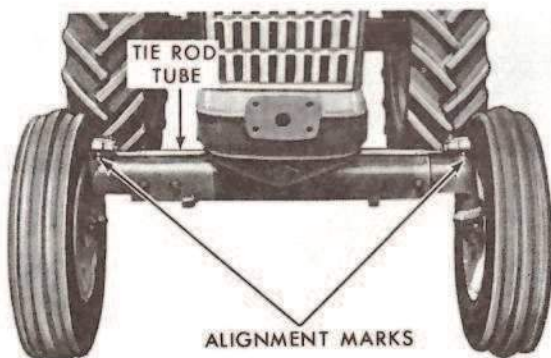
#### Adjusting Toe-In

##### **Ford 2000, 2110, 3000, 4000 SU, and 4110 (Manual Steering):**

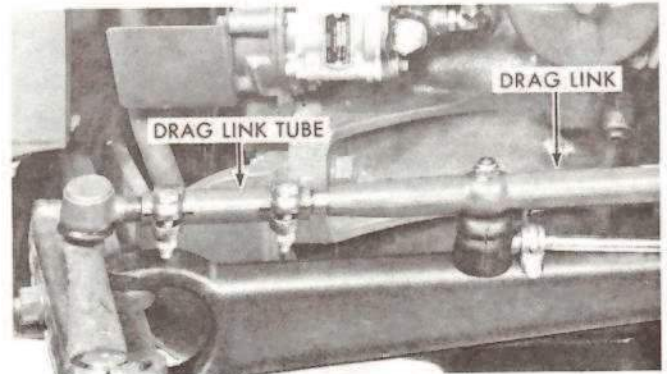
1. Loosen the drag link clamp bolts, Figure 126, at each end of the left and right drag links.
2. Turn each drag link the same number of turns to give zero to 1/2-inch toe-in.
3. After the correct toe-in is obtained, position the open side of the clamps in line with the slots in the drag links and tighten the clamps.

##### **Ford 2000, 2110, 3000, 4000 SU, and 4110 (Power Steering):**

1. Loosen the clamps on the left and right drag link tubes, Figure 128.



**Figure 127**  
**Toe-In Alignment Marks—Ford 4000 and 5000**



**Figure 128**  
**Drag Link Adjustment—Ford 2000, 2110, 3000, 4000 SU,**  
**and 4110 (Power Steering)**

2. Turn each tube the same number of turns to give zero to 1/2-inch toe-in.
3. After the correct toe-in is obtained, position the open side of the clamps in line with the slots in the tubes and tighten the clamps.

##### **Ford 4000 (Manual Steering and Power Steering):**

1. Remove the clamp bolt from the right-hand end of the tie rod tube, Figure 127, and loosen the right-hand tie rod end assembly attaching bolt.
2. Turn the connecting rod between the tie rod tube and tie rod end assembly, as required, to give zero to 1/2-inch toe-in.
3. After the correct toe-in is obtained, install and tighten the clamp bolt. Also tighten the tie rod end assembly attaching bolt.

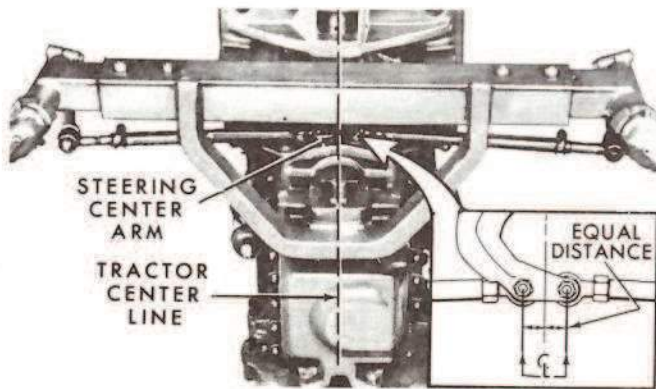
##### **Ford 5000 (Power Steering):**

1. Sight under the front support to make sure the steering center arm, Figure 129, is positioned so both the left and right inboard tie rod end assemblies are an equal distance from the center line of the tractor. Then, loosen the jam nuts and remove the tie rod clamp bolts from the outboard end of each tie rod.
2. Turn each tie rod the same number of turns to give zero to 1/2-inch toe-in.
3. After the correct toe-in is obtained, install the clamp bolts and tighten the jam nuts.

#### **BRAKE ADJUSTMENT**

Whenever the brake pedal travel becomes excessive, or if the travel of one pedal is unequal to that of the other, adjustment should be made in the following manner:

## LUBRICATION AND MAINTENANCE



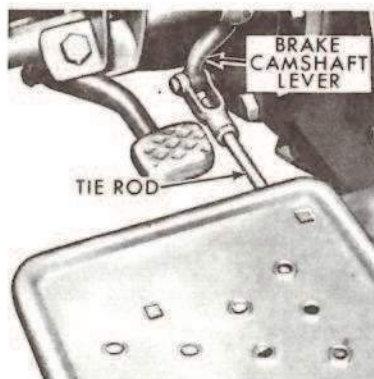
**Figure 129**  
Steering Center Arm Alignment—Ford 5000

### Ford 2000, 2110, 3000, and 4110:

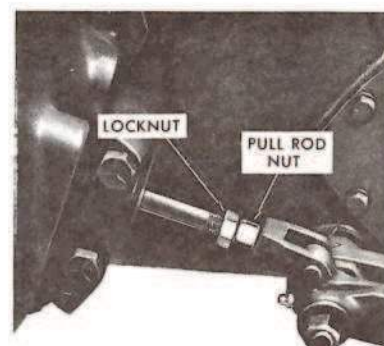
1. Jack the tractor up until both rear wheels are free to turn.
2. Remove the adjusting slot cover from the brake back plate and, with the brake pedals released, turn the adjusting screw clockwise, Figure 130, until the brake drags.
3. Back off the adjusting screw until the brake drags very slightly when the wheel is turned. Adjust both brakes in the same manner.
4. Adjust the right brake tie rod, Figure 131, with the clevis until the clevis pin can enter the hole when the brake camshaft lever is moved forward to take up the clearance.
5. Adjust the left brake tie rod with the clevis until both brake pedals are in line when both brakes are engaged.
6. Road test the tractor to make sure the braking action of both rear wheels is equal. Readjust if necessary.



**Figure 130**  
Brake Adjustment—Ford 2000,  
2110, 3000, and 4110



**Figure 131**  
Brake Tie Rod Adjustment—  
Ford 2000, 2110, 3000, and 4110



**Figure 132**  
Brake Adjustment—Ford 4000,  
4000 SU, and 5000

### Ford 4000, 4000 SU, and 5000

1. Disconnect the brake return spring on the right pedal, allowing the pedal to drop. Push the pedal down to take up any slack in the linkage.
2. Loosen the lock nut next to the pull rod nut, Figure 132, and turn the pull rod nut until the pedal is 1½ inches to 1¾ inches below the left pedal. Tighten the lock nut.
3. Disconnect the brake return spring on the left pedal, allowing the pedal to drop. Push the pedal down to take up any slack in the linkage.
4. Loosen the lock nut next to the pull rod nut and turn the pull rod nut until the left pedal is level with the right pedal. Check the adjustment by engaging the brake pedal lock. The brake pedal lock should engage easily if the pedals are aligned. This will give even braking action which is particularly important at road speeds.
5. Tighten the lock nut and install both brake pedal return springs.
6. Road test the tractor to make sure the braking action of both rear wheels is equal. Readjust if necessary.

### CLUTCH PEDAL ADJUSTMENT

To obtain maximum clutch life, it is essential that the clutch pedal free travel be checked every 50 hours so as to maintain free travel at 1¼ inches. Free travel is the distance the pedal can be moved before resistance is met, Figure 133. If the pedal free travel is excessive or insufficient, adjust as follows:

1. Loosen the clevis lock nut, Figure 134, and remove the cotter pin and clevis pin.
2. Turn the clevis to increase or decrease the effective length of the operating rod until the correct pedal free travel is obtained.



Figure 133  
Clutch Pedal Free Travel

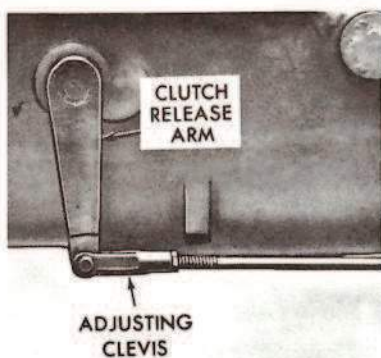


Figure 134  
Clutch Pedal Free Travel Adjustment

3. Install the clevis pin, secure with a new cotter pin and tighten the clevis lock nut.
4. Recheck the pedal free travel. Readjust if necessary.

#### "BLOCKING OUT" HYDRAULIC LIFT SYSTEM UPPER LINK TENSION LOADS

##### Ford 3000, 4000, and 4000 SU

When grading and backfilling with light equipment, such as a rear blade, the equipment may have a tendency to "dive." If this condition is encouraged, a spacer (available from your Ford Tractor-Equipment Dealer) can be installed between the draft control main spring and spring seat to correct the condition. See Figure 135.

To install the spacer:

1. Loosen the tractor seat attaching nuts and push the base of the seat forward.
2. Remove the pin that attaches the hydraulic lift rocker to the yoke, Figure 135. Pull the rocker back and unscrew the yoke.
3. Remove the three bolts and lock washers from the spring housing and pull the housing from the tractor, along with the washer, spring, and spring seat.

4. Remove the spring seat and any shims that may be behind the seat from the counterbore of the housing.
5. Install the spacer over the spring seat as shown. Install the spring seat and any shims that were removed, then attach the assembled housing to the tractor with the three bolts and lock washers previously removed.
6. Screw the yoke on the plunger until all free play is eliminated, then back the yoke out until the hole is horizontal. Do not back the yoke out more than is necessary to position the hole horizontally.
7. Attach the hydraulic lift rocker to the yoke with the pin previously removed.
8. Move the base of the tractor seat to the original position and tighten the attaching nuts.

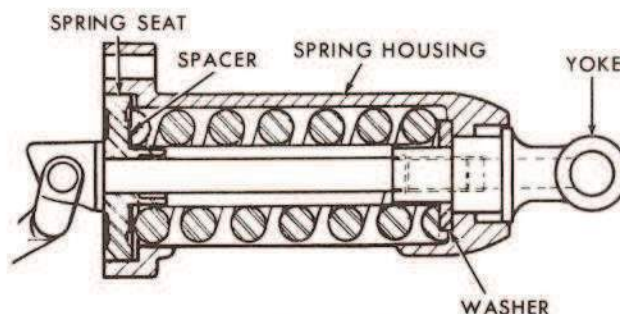


Figure 135  
Spacer Installation—Ford 3000, 4000, and 4000 SU

## TRACTOR STORAGE

Tractors that are to be stored for an extended period should be protected during storage. The following is a suggested list of operations to be carried out.

1. Thoroughly clean the tractor. Use touch-up paint where necessary to prevent rust.
2. Check the tractor for worn or damaged parts. Install new parts as required.
3. Raise the lift arms hydraulically to their fully raised position so the lift piston is in a fully extended position. This will protect the cylinder wall surfaces from corrosion.
4. Lubricate the tractor. Drain and refill the transmission and the rear axle hydraulic lift system with new oil. Drain the engine oil and refill with new lubricating oil. Also clean the air cleaner.
5. **Gasoline Tractors:** Drain the fuel tank and run the engine until it stops. Remove the drain plug from the carburetor float chamber to drain any remaining fuel.

# LUBRICATION AND MAINTENANCE

- Remove the spark plugs and pour three ounces of lubricating oil into each cylinder.
  - Crank the engine several revolutions with the key-starter switch. This procedure will coat the cylinder walls and piston rings with an oil film that will help prevent rust and permit easier starting when the tractor is removed from storage.
  - Reinstall the spark plugs, but do not run the engine.
6. **Diesel Tractors:** If the tractor is stored or removed from operation for an extended period, special precautions should be taken to protect the fuel injection pump and the injector nozzles against corrosion and gumming during the storage period.
- Before storing, the fuel system should be flushed with a special oil, a quantity of which will remain in the system when the engine is shut down for storage.
  - Special diesel fuel system flushing oils are available from most oil companies. If special flushing oil is not readily obtainable, mix one U.S. pint (0.8327 Imp. pt.) of SAE 10 non-detergent engine oil with 10 U.S. quarts (8.33 Imp. qts.) of No. 2 diesel fuel.
  - Drain the fuel tank and pour two U.S. gallons (1.67 Imp. gals.) of the special flushing oil (or lubricating mixture) in the fuel tank.
  - Run the engine for 10 minutes to assure complete distribution of the special oil through the injection pump and fuel injectors. There is no need to remove the injector nozzles.
  - Fill the fuel tank with No. 1 diesel fuel.

**IMPORTANT:** Do not use No. 2 diesel fuel for winter storage because of wax separation and settling at low temperatures.

7. Drain the radiator and engine block. Flush the system, close the drain valves, and fill with antifreeze that contains a rust inhibitor.
8. Remove the battery and clean it thoroughly. Be sure that it is fully charged, and that the electrolyte is to its proper level. Place it in storage in a cool, dry place above freezing temperature. The battery should be charged periodically during storage.
9. Place blocking under the tractor axles to remove the weight from the tires.
10. Cover the exhaust pipe opening.

Tractors that have been placed in storage should be completely serviced in the following manner before using:

1. Inflate the tires to the recommended pressures, and remove the blocking.
2. Fill the fuel tank with fuel. Check the oil level in the crankcase, hydraulic lift system (rear axle), transmission, and if equipped, the power steering reservoir and oil bath air cleaner.
3. Install a fully charged battery and remove the exhaust cover, if other than a rain cap.
4. Check the cooling system. Use corrosion inhibitor in warm weather; permanent antifreeze in cold weather.
5. Start the engine and allow it to idle a few minutes. Be sure the engine is receiving lubrication and that each control is functioning correctly.
6. Drive the tractor without a load to be sure it is operating satisfactorily.

## ACCESSORIES

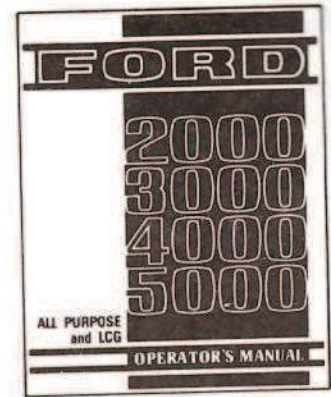
The following accessories are available from your Ford Tractor-Equipment Dealer.

ACCESSORY	2000	2110	3000	4000	4000SU	4110	5000
• Auxiliary Services Control Valve	X	X	X	X	X	X	Std.
• Remote Control Valve	X	X	X	X	X	X	X
• Double-Acting Remote Cylinder	X	X	X	X	X	X	X
• Quick Release Coupling	X	X	X	X	X	X	X
• Category I to II Conversion Kit	—	—	X	X	X	—	—
• Category II to I Conversion Kit	—	—	—	—	—	—	X
• Linkage Stabilizer Bar	X	—	X	X	X	—	X
• Clevis for Swinging Drawbar	X	X	X	X	X	X	X
• Linkage Drawbar	X	X	X	X	X	X	X
• Equipment Work Light Kit	X	X	X	X	X	X	X
• Equipment Warning Light Kit	X	X	X	X	X	X	X
• Deluxe Seat	X	X	X	Std.	Std.	Std.	Std.
• Roll Bar and Seat Belt	X	X	X	X	X	X	X

ACCESSORY	2000	2110	3000	4000	4000SU	4110	5000
• Diesel Air Pre-Cleaner and Stack	X	X	X	X	X	X	X
• Belt Pulley and Guard	X	X	X	X	X	X	X
• Bumper	X	X	X	—	X	—	—
• Canvas Cab	X	X	X	X	X	X	X
• Dual Rear Wheels	—	X	—	X	—	X	X
• Grease Gun and Holster	X	X	X	X	X	X	X
• Spark Plug Tire Pump (Gasoline)	X	X	X	X	X	X	X
• Bumper Weights	X	—	X	—	X	—	—
• Front End Weights	X	X	X	X	X	X	X
• Front Wheel Weights	X	—	X	X	X	—	X
• Rear Wheel Weights	X	—	X	X	X	—	X
• Diesel Engine Starting Aids	X	X	X	X	X	X	X
• Power Steering	X	X	X	X	Std.	X	Std.
• Tool Box	X	Std.	Std.	Std.	Std.	Std.	Std.



# specifications



The specifications on the following pages are provided for your information and reference.  
For additional information, see your Ford Tractor-Equipment Dealer.



**Properly maintained Equipment  
is Safe Equipment.**

# SPECIFICATIONS

## CAPACITIES

	Ford 2000	Ford 2110	Ford 3000	Ford 4000	Ford 4000 SU	Ford 4110	Ford 5000
<b>Fuel Tank:</b>	13 U.S. gals. (10.8 Imp. gals.)	13 U.S. gals. (10.8 Imp. gals.)	13 U.S. gals. (10.8 Imp. gals.)	16 U.S. gals. (13.3 Imp. gals.)	13 U.S. gals. (10.8 Imp. gals.)	13 U.S. gals. (10.8 Imp. gals.)	20 U.S. gals. (16.6 Imp. gals.)
<b>Cooling System:</b>	13.2 U.S. qts. (11.0 Imp. qts.)	13.2 U.S. qts. (11.0 Imp. qts.)	13.8 U.S. qts. (11.5 Imp. qts.)	14.0 U.S. qts. (11.6 Imp. qts.)	14.0 U.S. qts. (11.6 Imp. qts.)	14.0 U.S. qts. (11.6 Imp. qts.)	15.3 U.S. qts. (12.8 Imp. qts.)
<b>Engine Crankcase:</b>							
With Filter Change	7 U.S. qts. (5.8 Imp. qts.)	7 U.S. qts. (5.8 Imp. qts.)	7 U.S. qts. (5.8 Imp. qts.)	7 U.S. qts. (5.8 Imp. qts.)	7 U.S. qts. (5.8 Imp. qts.)	7 U.S. qts. (5.8 Imp. qts.)	9 U.S. qts. (7.5 Imp. qts.)
Without Filter Change	6 U.S. qts. (5 Imp. qts.)	6 U.S. qts. (5 Imp. qts.)	6 U.S. qts. (5 Imp. qts.)	6 U.S. qts. (5 Imp. qts.)	6 U.S. qts. (5 Imp. qts.)	6 U.S. qts. (5 Imp. qts.)	8 U.S. qts. (6.7 Imp. qts.)
<b>Hydraulic Lift System (Rear Axle):</b>							
With Trans. P.T.O.	24.6 U.S. qts. (20.5 Imp. qts.)	24.6 U.S. qts. (20.5 Imp. qts.)	24.6 U.S. qts. (20.5 Imp. qts.)	33.9 U.S. qts. (28.3 Imp. qts.)	—	—	—
With Live P.T.O.	24.6 U.S. qts. (20.5 Imp. qts.)	24.6 U.S. qts. (20.5 Imp. qts.)	24.6 U.S. qts. (20.5 Imp. qts.)	—	—	24.6 U.S. qts. (20.5 Imp. qts.)	—
With Ind. P.T.O.	—	—	—	33.9 U.S. qts. (28.3 Imp. qts.)	33.9 U.S. qts. (28.3 Imp. qts.)	24.6 U.S. qts. (20.5 Imp. qts.)	39.6 U.S. qts. (33 Imp. qts.)
<b>Transmission:</b>							
6-Speed (Trans. P.T.O.)	14.4 U.S. qts. (12 Imp. qts.)	14.4 U.S. qts. (12 Imp. qts.)	13.8 U.S. qts. (11.5 Imp. qts.)	—	—	—	—
6-Speed (Live P.T.O.)	14.4 U.S. qts. (12 Imp. qts.)	14.4 U.S. qts. (12 Imp. qts.)	13.8 U.S. qts. (11.5 Imp. qts.)	—	—	—	—
8-Speed (Trans. P.T.O.)	14.4 U.S. qts. (12 Imp. qts.)	14.4 U.S. qts. (12 Imp. qts.)	13.8 U.S. qts. (11.5 Imp. qts.)	13.8 U.S. qts. (11.5 Imp. qts.)	—	—	—
8-Speed (Live P.T.O.)	14.4 U.S. qts. (12 Imp. qts.)	14.4 U.S. qts. (12 Imp. qts.)	13.8 U.S. qts. (11.5 Imp. qts.)	—	—	13.8 U.S. qts. (11.5 Imp. qts.)	—
8-Speed (Ind. P.T.O.)	—	—	—	13.8 U.S. qts. (11.5 Imp. qts.)	13.8 U.S. qts. (11.5 Imp. qts.)	—	12 U.S. qts. (10 Imp. qts.)
Select-O-Speed	—	12.0 U.S. qts. (9.9 Imp. qts.)	12.0 U.S. qts. (9.9 Imp. qts.)	13.3 U.S. qts. (11 Imp. qts.)	—	12 U.S. qts. (10 Imp. qts.)	12.3 U.S. qts. (10.5 Imp. qts.)
Belt Pulley (Accessory)	0.6 U.S. qts. (0.5 Imp. qts.)	0.6 U.S. qts. (0.5 Imp. qts.)	0.6 U.S. qts. (0.5 Imp. qts.)	1.2 U.S. qts. (1 Imp. qts.)	1.2 U.S. qts. (1 Imp. qts.)	1.2 U.S. qts. (1 Imp. qts.)	1.2 U.S. qts. (1 Imp. qts.)

## ENGINE

	Ford 2000 & 2110		Ford 3000		Ford 4000, 4000 SU & 4110		Ford 5000	
	Gasoline	Diesel	Gasoline	Diesel	Gasoline	Diesel	Gasoline	Diesel
Type								
No. of Cylinders	3	3	3	3	3	3	4	4
Bore	4.2 in.	4.2 in.	4.2 in.	4.2 in.	4.4 in.	4.4 in.	4.4 in.	4.4 in.
Stroke	3.8 in.	3.8 in.	3.8 in.	4.2 in.	4.4 in.	4.4 in.	4.2 in.	4.2 in.
Displacement	158 cu. in.	158 cu. in.	158 cu. in.	175 cu. in.	201 cu. in.	201 cu. in.	256 cu. in.	256 cu. in.
Compression Ratio	7.75:1	17.5:1	7.75:1	16.5:1	7.75:1	16.5:1	7.75:1	16.5:1
Firing Order	1-2-3	1-2-3	1-2-3	1-2-3	1-2-3	1-2-3	1-3-4-2	1-3-4-2
Idle Speed (rpm)	600-700	600-700	600-700	600-700	600-700	600-700	600-700	600-700
Maximum Speed:								
N <sub>B</sub> Load (rpm)	2065-2165	2225-2275	2285-2385	2225-2275	2395-2495	2425-2475	2285-2385	2325-2375
Rated (rpm)	1900	2000	2100	2000	2200	2200	2100	2100
Valve Clearance (Lash— Warm Engine):								
Intake				all models—0.014 in. go		0.016 in. no-go		
Exhaust				all models—0.017 in. go		0.019 in. no-go		
Oil Pump Pressure Range				all models—14 to 38 psi at 600-700 rpm with temperatures up to 200°F				

Engine Oil ..... Ford M-2C121-A  
 (SAE 30 for Summer use—above 32° F)  
 (SAE 10W for Winter use—below 32° F)

**NOTE:** Ford Tractor 300 Engine Oil, a super premium, heavy duty low ash engine oil compounded specifically to meet the rigid requirements of Ford tractor engines, is available from your Ford Tractor-Equipment Dealer. Should you prefer to use an equivalent commercial oil, refer to the following chart:

Temperature	Viscosity Grade and API Classification	
	Diesel	Gasoline
Below + 10° F.	SAE 5W (DM)	SAE 5W (MS) or SAE 5W-20 (MS)
+ 10° F. to 40° F.	SAE 10W (DS)	SAE 10W (MS) or SAE 5W-20 (MS)
32° F. to 90° F.	SAE 20 (DS)	SAE 20 (MS) or SAE 10W-30 (MS)
Above 75° F.	SAE 30 (DS)	SAE 30 (MS) or SAE 10W-30 (MS)

When using diesel fuel with a sulfur content below 1.0%, diesel engine oil with an API Classification of DM may be used instead of a DS oil, but the oil and filter change interval must be reduced to 150 hours. When the sulfur content of a fuel is greater than 1.0%, but less than 1.3%, a DS oil must be used (except for temperatures of 10° F. and below), and the oil and filter change interval must be reduced to 150 hours. The use of fuel with a sulfur content above 1.3% is not recommended.

#### COOLING SYSTEM

Type ..... pressurized liquid, recirculating bypass  
 Water Pump:  
 Type ..... centrifugal  
 Drive ..... V-belt  
 Fan:  
 Diameter ..... 16 in.  
 Fan Belt Deflection ..... ¼ to ½ in. with 60-90  
 lbs. force applied midway  
 between generator and  
 crankshaft pulleys  
 Thermostat:  
 Starts to Open ..... 168° F.  
 Fully Open ..... 192° F.  
 Radiator Cap ..... 7 psi

#### ELECTRICAL SYSTEM

Generator ..... 12-volt, shunt-wound  
 Output ..... 22 amps.  
 Regulator ..... current voltage  
 Battery:  
 Gasoline Engine except Ford 5000  
 with Select-O-Speed ..... 80 amp. hour rating  
 Diesel Engine and Ford 5000 Gasoline  
 with Select-O-Speed ..... 128 amp. hour rating  
 Ground ..... negative  
 Starting Motor ..... positive engagement  
 Headlamp Sealed Beam Unit ..... No. 4419  
 Tail Lamp Bulb ..... No. 1155  
 Flasher Warning Lamp Bulb ..... No. 1156  
 Instruments and Warning Light Bulb ..... No. 1895

#### IGNITION SYSTEM

Diesel:  
 Type ..... compression  
 Gasoline:  
 Type ..... spark  
 Method ..... coil and distributor  
 Distributor Point Gap — Breaker ..... 0.022-0.028 in.  
 Dwell Angle ..... 35-38°  
 Timing (at 600-700 rpm with vacuum line  
 disconnected): ..... 2° ± 2° btdc  
 Spark Plugs:  
 Type ..... Autolite AG5  
 Gap ..... 0.023-0.027 in.

#### FUEL SYSTEM

Carburetor (Gasoline):  
 Type ..... updraft  
 Initial Adjustment (Idle Screw) ..... approximately  
 one full turn out  
 Injection Pump (Diesel):  
 Type:  
 Ford 3000 and 5000 ..... in-line  
 Ford 2000, 4000, 4000 SU, and 4110 ..... distributor  
 Timing ..... 19° btdc

#### CLUTCH

Type:  
 Ford 2000, 2110, 3000, and 4110  
 w/Transmission P.T.O. .... 11 in. single, dry plate  
 Ford 2000, 2110, 3000, and 4110  
 w/Live P.T.O. .... 11 in. double (11 in. main disc  
 and 8½ in. P.T.O. disc), dry plate

# SPECIFICATIONS

## CLUTCH—Cont.

Ford 4000, and 4000 SU w/Independent P.T.O. ....	11 in. single dry plate
Ford 5000 w/Independent P.T.O. ....	12 in. single dry plate
Pedal Free Travel (All Models) .....	1¼ inches

## BRAKES

Ford 2000, 2110, 3000, and 4110:	
Type .....	mechanical (expanding shoe)
Drum Diameter .....	14 in.
Shoe Width .....	1½ in.
Total Lining Area .....	98½ sq. in.
Ford 4000, 4000 SU, and 5000:	
Type .....	mechanical (wet disc)
Disc Diameter:	
Ford 4000 and 4000 SU .....	8.0 in. O.D. 6.8 in. I.D.
Ford 5000 .....	8.75 in. O.D. 7.4 in. I.D.
Lining Area:	
Ford 4000 and 4000 SU .....	168.0 sq. in.
Ford 5000 .....	287.2 sq. in.

## STEERING

Type .....	manual or hydraulic power assist
Turns Lock-to-Lock:	
Ford 2000, 3000, 4000 SU, and 4110 .....	2½
Ford 4000 .....	4½
Ford 5000 .....	4
Power Assist Pump:	
Type .....	gear
Capacity:	
At 700 rpm .....	2.5 U.S. gpm (2.1 Imp. gpm) (min.)
At 2000 rpm (Ford 2000, 2110, 3000, 4000 SU, and 4110) .....	4.25 U.S. gpm (3.5 Imp. gpm) (max.)
At 2200 rpm (Ford 4000 and 5000) .....	4.5 U.S. gpm (3.8 Imp. gpm) (max.)
Relief Valve Setting:	
Ford 2000, 2110, 3000, 4000 SU, and 4110 ..	600-700 psi
Ford 4000 .....	800-900 psi
Ford 5000 .....	1050-1150 psi

## POWER TAKE-OFF

Engine Speed for 540 rpm P.T.O. Speed:	
6-Speed (Transmission and Live P.T.O.) ....	1800 rpm
8-Speed (Transmission P.T.O.):	
Ford 2000 and 3000 .....	1600 rpm
Ford 4000 .....	1800 rpm
8-Speed (Live P.T.O.):	
8-Speed (Independent P.T.O.):	
Ford 4000 and 4000 SU .....	1800 rpm
Ford 5000 .....	1900 rpm
Select-O-Speed:	
Ford 2110, 3000, 4000, and 4110 .....	1800 rpm
Ford 5000 .....	1900 rpm
Engine Speed for 1000 rpm P.T.O. Speed:	
Deluxe Select-O-Speed .....	1950 rpm

## HYDRAULIC LIFT SYSTEM

Type:	
Ford 2000, 2110, and 4110 .....	live with single-acting draft control and Category I 3-point linkage.
Ford 3000 .....	live with dual sensing draft control, flow control, position control, and Category I 3-point linkage.
Ford 4000 and 4000 SU ..	live with dual sensing control flow control, position control, and Category I 3-point linkage.
Ford 5000 .....	live with dual sensing draft control, flow control, position control, and Category II 3-point linkage.
Pump Type:	
Ford 2000, 2110, 3000, 4000, and 4110 w/Select-O-Speed .....	piston, engine driven
Ford 4000, and 4000 SU w/8-speed and all Ford 5000's (Independent P.T.O.) .....	gear, P.T.O. driven
Pump Capacity:	
Ford 2000, 2110, and 4110 .....	4 U.S. gpm (3.3 Imp. gpm) at 2000 rpm
Ford 3000 and 4000 with External Piston-Type Pump .....	5 U.S. gpm (4.2 Imp. gpm) at 2000 rpm
Ford 4000, and 4000 SU with Internal Gear-Type Pump .....	5.5 U.S. gpm (4.6 Imp. gpm) at 2200 rpm
Ford 5000 .....	6 U.S. gpm (5.0 Imp. gpm) at 2100 rpm
System Relief Valve Setting .....	2500 psi

### CAST IRON WEIGHTS

Front Wheel Weights	42½ pounds each two per wheel
Rear Wheel Weights:	
Ford 2000 and 3000 (24- and 28-inch Wheels — Manual Adjust)	70 pounds each
(28-inch Wheels — Power Adjust)	80 pounds each
Ford 4000 and 5000 —	
(30-Inch Wheels — Manual Adjust)	70 pounds each
30-Inch Wheels — Power Adjust)	100 pounds each
(38-Inch Wheels — Manual or Power Adjust)	100 pounds each

### Front End Weights:

Ford 2000 and 3000	100 pounds each
Ford 4000 and 4000 SU	80 pounds each
Ford 5000	80 pounds each

### LUBRICANTS

Manual Shift Transmission	Ford M-2C53-A
Select-O-Speed Transmission	Ford M-2C41-A
Hydraulic System (Rear Axle)	Ford M-2C53-A
Belt Pulley	Ford M-2C53-A
Steering Gear Housing (Manual and Power)	Ford M-2C53-A
Power Steering Reservoir	Ford M-2C41-A
Front Wheel Bearings and All Lubrication Fittings	good quality, multi-purpose, lithium base, cup-type grease

### TIRES

	Ford 2000	Ford 2110 & 4110	Ford 3000	Ford 4000	Ford 4000 SU	Ford 5000
<b>Front</b>						
Standard	5.50-16 (4 ply F2)	6.50-13 (4 ply F3)	5.50-16 (4 ply F2)	6.00-16 (4 ply F2)	7.50-15 (6 ply F2)	6.00-16 (4 ply F2)
Optional		6.00-16 (4 ply I1) 9.00-10 (4 ply I1)	6.00-16 (4 ply F2)	7.50-16 (4 ply F2) 7.50-18 (4 ply F2)	7.50-16 (6 ply F2)	7.50-16 (4 ply F2) 7.50-18 (4 ply F2)
<b>Rear</b>						
Standard	11.2-28 (4 ply R1)	8.3-24 (4 ply R3)	12.4-28 (4 ply R1)	12.4-38 (4 ply R1)	14.9-28 (4 ply R1)	13.6-38 (4 ply R1)
Optional	12.4-28 (4 ply R1) 13.6-24 (4 ply R1)	18.4-16A (6 ply R3)	13.6-28 (4 ply R1) 14.9-24 (4 ply R1) 16.9-24 (6 ply R3)	13.6-38 (4 ply R1) 13.6-38 (6 ply R2-0) 14.9-30 (6 ply R1) 16.9-26 (6 ply R3) 16.9-30 (6 ply R1) 18.4-26 (6 ply R3)	16.9-24 (6 ply R1) 16.9-24 (6 ply R3)	15.5-38 (6 ply R1) 15.5-38 (6 ply R2-0) 16.9-30 (6 ply R1) 18.4-26 (6 ply R3) 18.4-30 (6 ply R1) 18.4-30 (6 ply R2-0)

### GENERAL DIMENSIONS

	Ford 2000	Ford 2110 & 4110	Ford 3000	Ford 4000	Ford 4000 SU	Ford 5000
Length	126½ in.	116 in.	127 in.	137 in.	128½ in.	141¾ in.
Height:						
To Top of Exhaust	79¾ in.	75¾ in.	83 in.	84¾ in.	86 in.	86¾ in.
To Hood Line	52½ in.	47½ in.	54 in.	57½ in.	52¾ in.	60¾ in.
To Steering Wheel	57½ in.	54¼ in.	58 in.	63 in.	58¾ in.	63½ in.
Width:						
At Minimum Track	63¾ in.	68¾ in.	64 in.	67½ in.		68½ in.
Ground Clearance:						
At Front Axle	21½ in.	16 in.	21½ in.	19½ in.	22 in.	18 in.
At Transmission	12¾ in.	8¾ in.	13¾ in.	17¼ in.		16¼ in.
Turning Radius:						
Without Brakes	10 ft. 9 in.	10 ft. 9 in.	10 ft. 9 in.	11 ft. 6 in.		12 ft. 3 in.
With Brakes	9 ft. 9 in.	9 ft. 9 in.	9 ft. 9 in.	10 ft.	9 ft. 9 in.	10 ft. 0 in.
Weight (Less Options)	3615 lbs.	3530 lbs.	3700 lbs.	4375 lbs.	4245 lbs.	5330 lbs.
Wheelbase	75-13/16 in.	75-13/16 in.	75-13/16 in.	84½ in.	77-5/16 in.	87½ in.

# SPECIFICATIONS

## TRACTOR GROUND SPEED CHARTS

**FORD 2000, 2110, and 3000 6-SPEED TRANSMISSION**

Gear	1000 rpm mph	1500 rpm mph	1900 rpm mph	2000 rpm mph
1st	0.7	1.0	1.3	1.4
2nd	1.3	2.0	2.5	2.6
3rd	2.1	3.2	4.0	4.2
4th	2.9	4.4	5.5	5.8
5th	3.8	5.7	7.2	7.6
6th	8.7	13.1	16.5	17.4
Rev. Low	1.2	1.8	2.3	2.4
Rev. High	3.5	5.3	6.7	7.0

**FORD 2000, 2110, 3000 AND 4110 8-SPEED TRANSMISSION**

Gear	1000 rpm mph	1500 rpm mph	1900 rpm mph	2000 rpm mph	2100 rpm mph
1st	0.8	1.2	1.6	1.6	1.7
2nd	1.0	1.5	1.9	2.0	2.1
3rd	1.8	2.7	3.4	3.6	3.8
4th	2.4	3.6	4.6	4.8	5.1
5th	2.9	4.4	5.6	5.8	6.1
6th	3.6	5.4	6.9	7.2	7.6
7th	6.4	9.6	12.2	12.8	13.4
8th	8.7	13.1	16.5	17.4	18.3
Rev. Low	1.2	1.8	2.2	2.4	2.5
Rev. High	4.2	6.3	8.0	8.4	8.8

**FORD 4000 SU 8-SPEED TRANSMISSION**

Gear	1000 rpm mph	1500 rpm mph	2000 rpm mph	2200 rpm mph
1st	0.6	0.9	1.2	1.4
2nd	0.8	1.2	1.6	1.8
3rd	1.4	2.1	2.8	3.1
4th	1.9	2.9	3.8	4.2
5th	2.3	3.5	4.6	5.0
6th	2.8	4.2	5.6	6.3
7th	5.0	7.5	10.0	11.0
8th	6.8	10.2	13.6	15.0
Rev. Low	0.9	1.4	1.8	2.0
Rev. High	3.3	5.0	6.6	7.2

**FORD 4000 8-SPEED TRANSMISSION**

Gear	1000 rpm mph	1500 rpm mph	2000 rpm mph	2200 rpm mph
1st	0.7	1.1	1.4	1.5
2nd	0.9	1.3	1.8	2.0
3rd	1.6	2.4	3.2	3.5
4th	2.1	3.2	4.2	4.7
5th	2.6	3.9	5.2	5.6
6th	3.2	4.8	6.4	7.0
7th	5.6	8.4	11.2	12.3
8th	7.6	11.4	15.2	16.8
Rev. Low	1.0	1.5	2.0	2.3
Rev. High	3.7	5.5	7.4	8.1

**FORD 5000 8-SPEED TRANSMISSION**

Gear	1000 rpm mph	1500 rpm mph	2000 rpm mph	2100 rpm mph
1st	0.8	1.1	1.5	1.5
2nd	0.9	1.4	1.8	2.0
3rd	1.7	2.5	3.4	3.5
4th	2.3	3.4	4.6	4.7
5th	2.7	4.0	5.4	5.6
6th	3.3	5.0	6.6	7.0
7th	5.9	8.9	11.8	12.4
8th	8.0	12.0	16.0	16.8
Rev. Low	1.1	1.6	2.2	2.3
Rev. High	3.9	5.8	7.8	8.1

**FORD 4000 SELECT-O-SPEED TRANSMISSION**

Gear	1000 rpm mph	1500 rpm mph	2000 rpm mph	2200 rpm mph
1st	0.5	0.7	1.0	1.1
2nd	0.7	1.0	1.4	1.5
3rd	0.8	1.2	1.6	1.8
4th	1.1	1.7	2.2	2.4
5th	1.8	2.7	3.6	4.0
6th	2.3	3.5	4.6	5.1
7th	2.6	3.9	5.3	5.7
8th	3.4	5.1	6.8	7.5
9th	5.5	8.3	11.0	12.1
10th	8.0	12.0	16.0	17.6
Rev. 1	1.5	2.3	3.1	3.4
Rev. 2	2.3	3.5	4.6	5.1

**FORD 2110 SELECT-O-SPEED TRANSMISSION**

Gear	1000 rpm mph	1500 rpm mph	1900 rpm mph
1st	0.5	0.7	1.0
2nd	0.7	1.0	1.3
3rd	0.7	1.2	1.5
4th	1.1	1.7	2.1
5th	1.8	2.7	3.4
6th	2.3	3.5	4.4
7th	2.7	4.1	5.1
8th	3.4	5.1	6.5
9th	5.2	8.3	10.5
10th	8.1	12.3	15.6
Rev. 1	3.4	2.4	3.0
Rev. 2	2.3	3.5	4.4

**FORD 4110 SELECT-O-SPEED TRANSMISSION**

Gear	1000 rpm mph	1500 rpm mph	2200 rpm mph
1st	0.5	0.7	1.1
2nd	0.7	1.0	1.5
3rd	0.8	1.2	1.8
4th	1.1	1.7	2.4
5th	1.8	2.7	4.0
6th	2.3	3.5	5.1
7th	2.6	3.9	5.7
8th	3.4	5.1	7.5
9th	5.5	8.3	12.1
10th	8.0	12.0	17.6
Rev. 1	1.5	2.3	3.4
Rev. 2	2.3	3.5	5.1

**FORD 3000 SELECT-O-SPEED TRANSMISSION**

Gear	1000 rpm mph	1500 rpm mph	2000 rpm mph	2100 rpm mph
1st	0.5	0.7	1.0	1.1
2nd	0.7	1.0	1.4	1.5
3rd	0.8	1.2	1.6	1.7
4th	1.1	1.7	2.2	2.4
5th	1.8	2.7	3.6	3.8
6th	2.3	3.5	4.6	4.8
7th	2.7	4.1	5.4	5.7
8th	3.4	5.1	6.8	7.2
9th	5.5	8.3	11.0	11.6
10th	8.2	12.3	16.4	17.2
Rev. 1	1.6	2.4	3.2	3.4
Rev. 2	2.3	3.5	4.6	4.8

**FORD 5000 SELECT-O-SPEED TRANSMISSION**

Gear	1000 rpm mph	1500 rpm mph	2000 rpm mph	2100 rpm mph
1st	0.5	0.7	0.9	1.0
2nd	0.7	1.0	1.4	1.5
3rd	0.8	1.2	1.6	1.7
4th	1.1	1.7	2.2	2.3
5th	1.7	2.6	3.4	3.6
6th	2.2	3.3	4.4	4.6
7th	2.5	3.8	5.0	5.3
8th	3.3	4.9	6.6	6.9
9th	5.3	8.0	10.6	11.1
10th	7.8	11.7	15.6	16.4
Rev. 1	1.5	2.2	3.0	3.1
Rev. 2	2.2	3.3	4.5	4.6

## PRE-DELIVERY SERVICE CHECK AND ADJUST AS REQUIRED

### INOPERATIVE SERVICE CHECKS:

1. Tire pressure
2. Air cleaner oil level and hose connections
3. Oil level in in-line injection pump
4. Clean gasoline fuel sediment bowl
5. Radiator coolant level
6. Fan belt
7. Battery cleanliness, vent openings, electrolyte level, and charge
8. Engine oil level
9. Transmission oil level
10. Hydraulic and rear axle center housing oil level
11. Starter safety switch operation
12. Hydraulic lift draft control mainspring adjustment
13. Upper link, drawbar, and pin in position
14. Steering gear box oil level
15. Power steering reservoir oil level
16. Brake adjustment and pedal equalization
17. Operation of brake pedal lock
18. Rear wheel-to-rim clamp bolts, lock nuts, or jack screws for tightness
19. Front and rear wheel disc and hub nuts for tightness
20. Front wheel toe-in

21. Fuel level
22. Sheet metal and paint condition
23. Tool box for Operator's Manual
24. Lift rod leveling crank for proper operation
25. Drain diesel fuel filter(s)

### OPERATIVE SERVICE CHECKS:

All operating checks are to be performed with the tractor at normal operating temperature.

1. Lights and instruments for proper operation
2. Fluid and oil leaks
3. Diesel maximum no-load speed and idle speed adjustments, and fuel shut-off
4. Carburetor and throttle linkage adjustment
5. Starting and starter safety switch
6. Select-O-Speed:
  - Band adjustment
  - Selector alignment
  - Drive line disengagement lever
7. P.T.O. engagement and disengagement:
  - Transmission type — clutch pedal and P.T.O. lever
  - Live type — 2-stage clutch pedal and P.T.O. lever

- Independent type — P.T.O. lever
- \*Select-O-Speed — T-handle adjustment, P.T.O.
- 1000 rpm stub shaft
- \*\*Ground speed shift lever
- \* Except Ford 5000
- \*\* Deluxe Select-O-Speed Transmission only

8. Hydraulic System:
  - Selection lever for draft and position control operation
  - Flow control operation
  - Draft control for tension and compression loads
  - Auxiliary service control or remote control valve (if installed)

### PERFORMANCE SERVICE CHECKS:

1. Engine operation including throttle and governor operation
2. Transmission including inching pedal or clutch
3. Steering control
4. Differential lock engagement and disengagement
5. Brake action
6. All optional equipment and accessories

TRACTOR MODEL NO. \_\_\_\_\_

INSPECTION PERFORMED — WARRANTY EXPLAINED

TRACTOR SERIAL NO. \_\_\_\_\_

OWNER'S SIGNATURE \_\_\_\_\_

DATE \_\_\_\_\_

DEALER'S SIGNATURE \_\_\_\_\_

DATE \_\_\_\_\_

## 50-HOUR SERVICE CHECK AND ADJUST AS REQUIRED

### INOPERATIVE SERVICE CHECKS:

1. Tire pressure
2. Change air cleaner oil and check hose connections
3. Dry air cleaner element, and hose connections
4. Replace diesel fuel filter(s) and bleed system
5. Change oil in in-line injection pump
6. Tighten in-line pump delivery valve holders
7. Clean gasoline fuel sediment bowl
8. Radiator coolant level
9. Fan belt
10. Battery cleanliness and vent openings, electrolyte level, and charge
11. All electrical cables, terminals, and wires
12. Drain and refill engine oil
13. Replace engine oil filter

14. Transmission oil level
15. Replace Select-O-Speed Filter
16. Hydraulic and rear axle center housing oil level
17. Steering gear box oil level
18. Power steering reservoir oil level
19. Rear wheel-to-rim clamp bolts, lock nuts, or jack screws for tightness
20. Spark plug gap
21. Injection pump timing
22. Cylinder head bolt torque

### OPERATIVE SERVICE CHECKS:

1. Lights and instruments for proper operation
2. Fluid and oil leaks
3. Diesel maximum no-load speed and idle speed adjustments, and fuel shut-off
4. Carburetor and throttle linkage adjustment
5. Distributor dwell and point spacing

6. Gasoline engine timing
7. Starting and starter safety switch
8. Select-O-Speed band adjustment
9. Valve lash
10. Hydraulic system:
  - Lift control lever adjustment
  - Selector lever for draft and position control operation
  - Flow control operation
  - Draft control for tension and compression loads

### PERFORMANCE SERVICE CHECKS:

1. Engine operation including throttle and governor operation
2. Transmission including inching pedal or clutch
3. Steering control
4. Differential lock engagement and disengagement
5. Brake action
6. All optional equipment and accessories

TRACTOR MODEL NO. \_\_\_\_\_

INSPECTION PERFORMED

TRACTOR SERIAL NO. \_\_\_\_\_

OWNER'S SIGNATURE \_\_\_\_\_

DATE \_\_\_\_\_

DEALER'S SIGNATURE \_\_\_\_\_

DATE \_\_\_\_\_





## PRE-DELIVERY SERVICE CHECK AND ADJUST AS REQUIRED

### INOPERATIVE SERVICE CHECKS:

1. Tire pressure
2. Air cleaner oil level and hose connections
3. Oil level in in-line injection pump
4. Clean gasoline fuel sediment bowl
5. Radiator coolant level
6. Fan belt
7. Battery cleanliness, vent openings, electrolyte level, and charge
8. Engine oil level
9. Transmission oil level
10. Hydraulic and rear axle center housing oil level
11. Starter safety switch operation
12. Hydraulic lift draft control mainspring adjustment
13. Upper link, drawbar, and pin in position
14. Steering gear box oil level
15. Power steering reservoir oil level
16. Brake adjustment and pedal equalization
17. Operation of brake pedal lock
18. Rear wheel-to-rim clamp bolts, lock nuts, or jack screws for tightness
19. Front and rear wheel disc and hub nuts for tightness
20. Front wheel toe-in

TRACTOR MODEL NO. \_\_\_\_\_

21. Fuel level
22. Sheet metal and paint condition
23. Tool box for Operator's Manual
24. Lift rod leveling crank for proper operation
25. Drain diesel fuel filter(s)

### OPERATIVE SERVICE CHECKS:

All operating checks are to be performed with the tractor at normal operating temperature.

1. Lights and instruments for proper operation
2. Fluid and oil leaks
3. Diesel maximum no-load speed and idle speed adjustments, and fuel shut-off
4. Carburetor and throttle linkage adjustment
5. Starting and starter safety switch
6. Select-O-Speed:
  - Band adjustment
  - Selector alignment
  - Drive line disengagement lever
7. P.T.O. engagement and disengagement:
  - Transmission type — clutch pedal and P.T.O. lever
  - Live type — 2-stage clutch pedal and P.T.O. lever

INSPECTION PERFORMED — WARRANTY EXPLAINED

- Independent type — P.T.O. lever
- \*Select-O-Speed — T-handle adjustment, P.T.O.
- 1000 rpm stub shaft
- \*\*Ground speed shift lever
- \* Except Ford 5000
- \*\* Deluxe Select-O-Speed Transmission only

8. Hydraulic System:
  - Selection lever for draft and position control operation
  - Flow control operation
  - Draft control for tension and compression loads
  - Auxiliary service control or remote control valve (if installed)

### PERFORMANCE SERVICE CHECKS:

1. Engine operation including throttle and governor operation
2. Transmission including inching pedal or clutch
3. Steering control
4. Differential lock engagement and disengagement
5. Brake action
6. All optional equipment and accessories

TRACTOR SERIAL NO. \_\_\_\_\_

OWNER'S SIGNATURE \_\_\_\_\_

DATE \_\_\_\_\_

DEALER'S SIGNATURE \_\_\_\_\_

DATE \_\_\_\_\_

## 50-HOUR SERVICE CHECK AND ADJUST AS REQUIRED

### INOPERATIVE SERVICE CHECKS:

1. Tire pressure
2. Change air cleaner oil and check hose connections
3. Dry air cleaner element, and hose connections
4. Replace diesel fuel filter(s) and bleed system
5. Change oil in in-line injection pump
6. Tighten in-line pump delivery valve holders
7. Clean gasoline fuel sediment bowl
8. Radiator coolant level
9. Fan belt
10. Battery cleanliness and vent openings, electrolyte level, and charge
11. All electrical cables, terminals, and wires
12. Drain and refill engine oil
13. Replace engine oil filter

TRACTOR MODEL NO. \_\_\_\_\_

14. Transmission oil level
15. Replace Select-O-Speed Filter
16. Hydraulic and rear axle center housing oil level
17. Steering gear box oil level
18. Power steering reservoir oil level
19. Rear wheel-to-rim clamp bolts, lock nuts, or jack screws for tightness
20. Spark plug gap
21. Injection pump timing
22. Cylinder head bolt torque

### OPERATIVE SERVICE CHECKS:

1. Lights and instruments for proper operation
2. Fluid and oil leaks
3. Diesel maximum no-load speed and idle speed adjustments, and fuel shut-off
4. Carburetor and throttle linkage adjustment
5. Distributor dwell and point spacing

INSPECTION PERFORMED

6. Gasoline engine timing
7. Starting and starter safety switch
8. Select-C-Speed band adjustment
9. Valve lash
10. Hydraulic system:
  - Lift control lever adjustment
  - Selector lever for draft and position control operation
  - Flow control operation
  - Draft control for tension and compression loads

### PERFORMANCE SERVICE CHECKS:

1. Engine operation including throttle and governor operation
2. Transmission including inching pedal or clutch
3. Steering control
4. Differential lock engagement and disengagement
5. Brake action
6. All optional equipment and accessories

TRACTOR SERIAL NO. \_\_\_\_\_

OWNER'S SIGNATURE \_\_\_\_\_

DATE \_\_\_\_\_

DEALER'S SIGNATURE \_\_\_\_\_

DATE \_\_\_\_\_



# index

	<u>Page</u>		<u>Page</u>
Adjustable Upper Link	35	Leveling Crank	35
Air Cleaner	54	Lift Linkage	31
Air Cleaner Restriction Indicator	6, 54	Light Switch	5
Attaching Equipment	35	Liquid Ballast	42
Auxiliary Service Control Valve	11, 28	Lubricant Storage	50
		Lubricants	50
Battery	69	Lubrication and Maintenance	45
Belt Pulley Operation	25	Lubrication and Maintenance Charts	46
Bleeding the Fuel System (Diesel)	53		
Brake Adjustment	71	Maintenance	45
Brake Pedals	7	Manual Shift Transmission Controls	9
Break-in Procedures	14	Manual Shift Transmission Operation	22
Charge Indicator Warning Light	6	Oil Levels	50
Clutch Pedal	9	Operation	13
Clutch Pedal Adjustment	72		
Cold Weather Starting	14	Parking Brake	7
Controls and Instruments	3	Position Control	27
Cooling System	61	Power Steering Reservoir	59
		P.T.O. Controls (Manual Transmissions)	9
Diesel Engine Excess Fuel Button	6	P.T.O. Controls (Select-O-Speed Transmissions)	7
Diesel Engine Speed Adjustments	64	P.T.O. Operation (Manual Transmissions)	23
Diesel Engine Stop Control	5	P.T.O. Operation (Select-O-Speed Transmissions)	18
Differential Lock	7	Pre-Cleaner Bowl	54
Distributor Points	67	Proof-Meter	6
Draft Control	28		
Drawbar	31	Radiator (Cooling System)	61
		Rear Wheel Tread Settings	37
Engine Controls	4	Remote Control Valves	11, 29
Engine Oil Pressure Warning Light	6	Remote Cylinder Couplings	31
Fan Belt	62	Safety Precautions	2
Flexible Link Ends	33	Seat	4
Flow Control	11, 28	Select-O-Speed Transmission Controls	7
Foot Throttle	5	Select-O-Speed Transmission Operation	17
Foot Throttle Adjustment	66	Service Procedures	50
Front Wheel Bearings	70	Spark Plugs	68
Front Wheel Toe-In	70	Specifications	75
Front Wheel Tread Settings	35	Stabilizers	33
Fuel Filter (Diesel)	52	Starting the Engine	14
Fuel Injection Pump Timing	63	Stopping the Engine	16
Fuel Injectors	64		
Fuel Shut-Off Valve	6	Temperature Gauge	5
Fuel Storage	48, 49	Thermostat	62
Fuels	48	Tire Pressure	43
		Towing Manual Shift Tractors	25
Gasoline Engine Choke Control	5	Towing Select-O-Speed Tractors	22
Gasoline Engine Speed Adjustments	65	Tractor Storage	73
Generator and Regulator	69		
		Upper Link	35
Hand Throttle	5		
Headlamps	69	Valve Clearance (Lash)	68
Hydraulic Lift System Controls	10	Voltage Regulator	69
Hydraulic Lift System Operation	27		
Hydraulic Selector Lever	11	Warning Lights	6
		Weighting	41
Ignition Timing	67	Wheel Tread Settings	35
		Winter Blend Oil (Hydraulic System)	58
Key-Starter Switch	5		



*The **BEST** source of  
information and help  
for old Ford tractors*

